



ACCESSORIES GUIDELINE



Click on reference

1. ALPHA RANGE :

Reference	Designation	Package
ALT-WL0.6	Front Cover - 2/3 Height Format for Alpha EM.	Unit
ALT-WB1	Front Cover + Wheels - Single Height Format for Alpha B1/ M3/M8.	Unit
ALT-WB1.3	Front Cover + Wheels - 4/3 Height Format for Alpha B1-18.	Unit
ALT-WB2	Front Cover + Wheels - Double Height Format for Alpha S2/EF.	Unit
ALT-XBOW	Alpha Crossbow Fly Frame.	
VXT-BRIDLE3	Complete System including links to the first cabinet and to the next XBOW.	Unit
ALT-XKIT	Heavy duty 3 legs clutch chain Bridle to O ring (link to motor).	Unit
ALT-EFFR	Cabinet-to-Cabinet connection kit. Includes 1 x XHINGE + 2 x XSTRAP.	Kit
ALT-EMFR	Rails / Fly Kit for one Alpha EF.	Kit
ALT-EMFR	Rails / Fly Kit for one Alpha EM.	Kit
ALT-VFR	Rails / Fly Kit for one Alpha B1-18.	Kit

2. GEO S RANGE:

Reference	Designation	Package
CDT-BUMPER12	Bumper Bar for CD12.	Unit
CDT-LINK12	Cabinet Connection Kit for CD12. Includes 4 x Straps.	Kit
CDT-LINKBAR12	GEO S805/830 Bumper to CD Bumper Link Bar.	Unit
GPI-ANPL1	0.2° To 3.15° GEO S12 Fixes Installation Angle Plates.	Pair
GPI-ANPL2	5° To 10° GEO S12 Fixes Installation Angle Plates.	Pair
GPI-ANPL3	16° To 30° GEO S12 Fixes Installation Angle Plates.	Pair
GPI-BUMPER	GEO S1210/1230 Fixed Installation Bumper.	Unit
GPT-2CASE	GEOS1210/130 Flight Case (2 Cabinets + accessories)	Unit
GPT-3CASE	GEOS1210/130 Flight Case (3 Cabinets)	Unit
GPT-BCASE	GEOS1210/130 Bumper Flight Case (2 Bumpers + accessories)	Unit
GPT-BUMPER	GEO S1210/1230 Main Bumper.	Unit
GPI-FLG	120° Dispersion Flanges.	Pair
GPT-GSTK	GEO S1210/1230 Ground Stacking Accessory.	Unit
GPT-PSBRK	GEO S12 Two Cabinets Pole Stand Bracket. (Max 2 Cabinets).	Unit
GPT-SSBRK	GEO S12 One Cabinet Speaker Stand Bracket.	Unit
GPT-TLB	GEO S1210/1230 Tension Mode, inter Cabinets link Bar.	Pair
GPT-XBOW	GEO S1210/1230 Mini Crossbow.	Pair
GST-7CASE	Flight Case for 7 x GEO S 805 and 1 x GST-BUMPER.	Unit
GST-830CASE	Flight Case for 2 x GEO S 830.	Unit
GST-BUMPER	Bumper Bar for GEOS805 & GEOS830.	Unit
GST-EXBAR	GEO S805/830 Bumper Suspension Angle Adjustment Bar.	Unit
GST-GRND	GEO S805/830 Ground Stacking Accessory	Unit
GST-HRPL	GEO S830 Horizontal Bumper	Unit
VNI-ABRK	GEO S1210/1230 Fixed Installation A Bracket.	Unit
VNI-LBRK	GEO S1210/1230 Fixed Installation L Bracket.	Unit
VNI-UBRK12	GEO S1210/1230 Fixed Installation U Bracket.	Unit
VNT-TCBRK	Truss Clamp Adapter.	Unit
VNT-TTC	GEO S1210/1230 Angle Adapter U Bracket.	Unit
VNT-XHBRK	GEO S1230 Mini Crossbow and VNT-TTC, Horizontal Bracket.	Unit
VXT-BL820	GEO S805/830 Quick Release Pin	Unit
VXT-BLTRAP	50 x T-RAP For VXT-BL820/1020/1230/1235.	Kit
VXT-BRIDLE2	Heavy Duty 2 Legs Clutch Chain Bridle.	Unit
VXT-LEVA750	Chain Lever Hoist 750 Kg.	Unit



3. GEO D RANGE:

Click on reference

Reference	Designation	Package
VXT-BL1020	GEO D10 Quick Release Pin.	Unit
VXT-BLTRAP	50 x T-RAP For VXT-BL820/1020/1230/1235.	Kit
GDI-BNFIK	GEOD10/GEOSUB Shoulder Bolt And Nuts Installation Kit.	Kit
GDT-BKM	GEO D10 Dolly Storage Tray.	Unit
GDT-BTBUMPER	GEO D10 Bottom Bumper.	Unit
GDT-BUMPER	GEO D10/GEOSUB Main Bumper.	Unit
GDT-BUPDP	Ground Stacking Accessories for GEO D10 Bumper.	Kit
GDT-DCOVER3	Nylon Cover For 3 GEO D10 + 1 GDT-BUMPER or 1 GDT-BKM, On a Dolly.	Unit
GDT-DCOVER4	Nylon Cover For 4 GEO D10 + 1 GDT-BUMPER or 1 GDT-BKM, On a Dolly.	Unit
GDT-DOLLY	3 x GEO D10 + 1 x GDT-BUMPER Dolly.	Unit
GDT-EXBAR1	Extension Bar For GEO D10 Cluster.	Unit
GDT-EXBAR2	Extension Bar For GEO D10/GEOSUB Cluster.	Unit
GDT-EXBAR3	Extension Bar For GEOSUB Cluster.	Unit
GDT-EXBAR4	Positive Angle Extender for GEO D10/GEOSUB Bumper.	Unit
GDT-ORP	GEO D10 Wheel For single Rigging Point Setup.	Unit
GDT-RAINCO	GEO D10 Waterproof Back Cover. (4 Cabinets)	Unit
GDT-RAINCOBP	GEO D10 Bumper Waterproof Back Cover. (Top Cabinet)	Unit
GDT-SUBCOVER	Nylon Cover For 2 GEOSUB + 1 GDT-BUMPER or 1 GDT-BKM, On a Dolly.	Unit
GDT-SUBDOLLY	2 x GEOSUB + 1 x GDT-BUMPER Dolly.	Unit
VXT-BRIDLE2	Heavy Duty 2 Legs Clutch Chain Bridle.	Unit
VXT-CHBAG	Chain Bag.	Unit
VXT-LEVA1500	Chain Lever Hoist 1500 Kg.	Unit
VXT-LEVA750	Chain Lever Hoist 750 Kg.	Unit
VNT-INCLST	GeoSight Sender Unit with laser option fitted.	Unit
VNT-INCMMT	GeoSight Meter Unit.	Unit
VXT-C30CT	30m cable for GeoSight.	Unit
VXT-C611F	EP6 Female Connector.	Unit
VXT-C612M	EP6 Male Connector.	Unit
VXT-C613F	EP6 Female Chassis Connector.	Unit
VXT-CCABLE	Cable For GEO T 4805/2815.	Meter

4. GEO T RANGE:

Reference	Designation	Package
CDT-WB18	CD 18 Wheel Board.	Unit
GTT-CASE	Flight Case for GEO T 4805/2815.	Unit
GTT-CASEEX3	Flight Case 3 Cabinets Extension Panels for GEO T 4805/2815.	Unit
GTT-BCCH	Compression Mode Kelping Chain.	Unit
GTT-BTBUMPER	Geo T Bottom Bumper.	Unit
GTT-BUMPER	Main Geo T bumper (4 x VXT-BL1235 Included).	Unit
GTT-KELPBEAM	Geo T Kelping Beam.	Unit
VXT-LEVA1500	Chain Lever Hoist 1500 Kg.	Unit
GTT-RAINCO	Geo T Waterproof Back Cover (up to 6 cabinets).	Unit
GTT-RAINCOBP	Geo T Bumper Waterproof Back Cover.	Unit
VNT-INCLST	GeoSight Sender Unit with laser option fitted.	Unit
VNT-INCMMT	GeoSight Meter Unit.	Unit
VXT-C30CT	30m cable for GeoSight.	Unit
VXT-C611F	EP6 Female Connector.	Unit
VXT-C612M	EP6 Male Connector.	Unit
VXT-C613F	EP6 Female Chassis Connector.	Unit
VXT-CCABLE	Cable For GEO T 4805/2815.	Meter
VXT-BL1230	GEO T4805/2815 Quick release Pin.	Unit
VXT-BL1235	GEO T Bumper Quick Release Pin.	Unit
VXT-BLTRAP	50 x T-RAP For VXT-BL820/1020/1230/1235.	Kit



Click on reference

5. PS RANGE:

Reference	Designation	Package
PSI-FLYCRA	PS15 Flying Cradle.	Unit
PSI-FLYCRAPS10	PS10 Flying Cradle.	Unit
PST-FLYANCPS10	Flying Anchor Plates for PS10.	Unit
PST-FLYANSP	Rapid Single Lock Ring.	Unit
PST-FLYLS	Rails / Fly Kit for one LS500 / LS1200.	Kit
PST-FLYPS10	Rails / Fly Kit for one PS10.	Kit
PST-FLYPS15	Rails / Fly Kit for one PS15.	Kit
VNI-UBRK8	Bracket "U" for PS8.	Unit
VNI-WS08	Fixed Hanging Bracket For PS8.	Unit
VNI-WS10	Fixed Hanging Bracket For PS10 R2.	Unit
VNI-WS15	Fixed Hanging Bracket For PS15 R2.	Unit
VNT-ADPT	PS Touring Cradle Adaptor	Unit
VNT-ADPT510	Bracket "B" for PS8.	Unit
VNT-LBRK8	Bracket "L" for PS8.	Unit
VNT-PSTAND8	Stand Adapter for PS8 (for use with VXT-PLSTD).	Unit
VNT-SSBRK10	PS10/PS10 R2 Touring Cradle.	Unit
VNT-SSBRK15	PS15/PS15 R2 Touring Cradle.	Unit
VNT-SSBRK8	PS8 Touring Cradle. (Includes VNT-ADPT).	Unit
VXT-PLSTD	Mast for PS8 / PS10 / PS15.	Unit
VXT-STDUPS10	U Bracket + Mast for PS8/PS10.	Kit
VXT-UPS10	U Bracket for PS8/PS10.	Unit

6. RS RANGE:

RSI-INSP15	RS15 Fixe installation cabinet to cabinet link. (Pair)	Pair
RST-BUMPER15	Bumper For RS15-C/P. (Maximum 16 Cabinets)	Unit
RST-DOLLY15	Dolly for RS15-C/P. (Maximum 3 Cabinets)	Unit
RST-FPLATES15	Rigging and Handles Set for RS15-C/P. (Pair)	Pair
RST-HANDLES15	Handles Set for RS15-C/P. (Pair)	Pair
RST-WHEELS15	Wheels Set for RS15-C/P. (Pair)	Kit
VXT-BL820	GEO S805/830/1210/1230, RS15-C/P Quick Release Pin.	Unit

7. NXAMP RANGE:

NAT-R1	NXAMP Rack; 1 Unit.	Unit
NAT-R2	NXAMP Rack; 2 Units.	Unit
NAT-R3	NXAMP Rack; 3 Units.	Unit
NAT-PP	NXAMP Patch Panel.	Unit
NAT-RSLV	NXAMP Patch Panel Sleeves Set.	Pair
NAT-HAND4X1	Handle Set For NXAMP4X1U/C.	Pair
NAT-HAND4X4	Handle Set For NXAMP4X4U/C.	Pair

ALT-EFFR

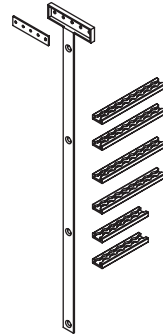

ALT-EMFR

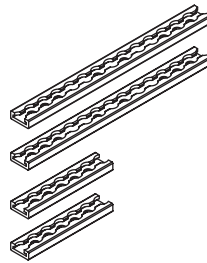

ALT-VFR

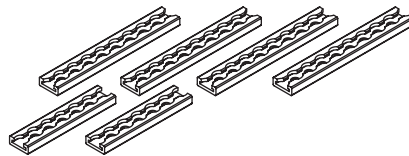

ALT-WB1

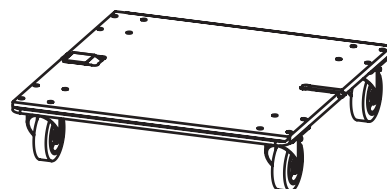

ALT-WB1.3

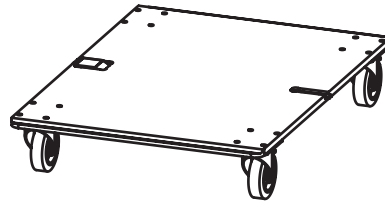

ALT-WB2

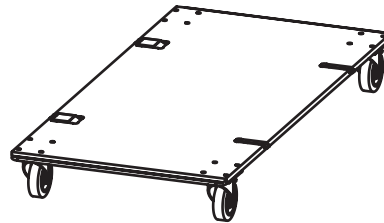

ALT-WL0.6

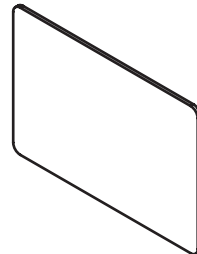

ALT-XBOW

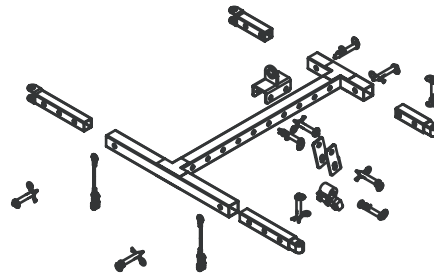

ALT-XKIT

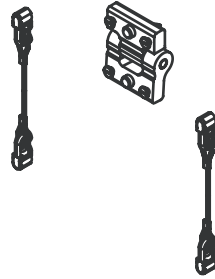

CDT-BUMPER12

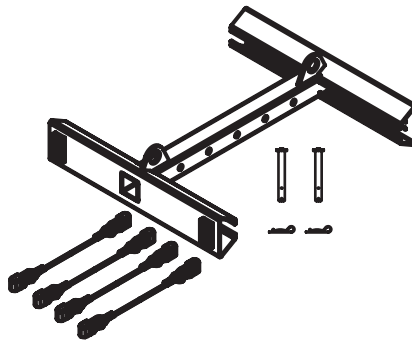

CDT-LINK12

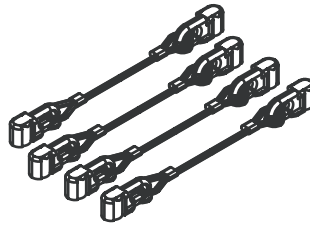

CDT-LINKBAR12

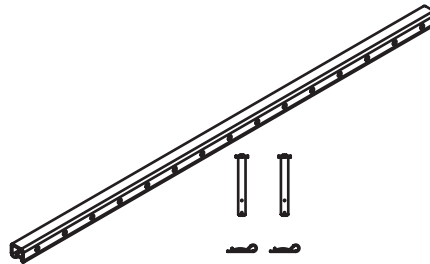

CDT-WB18

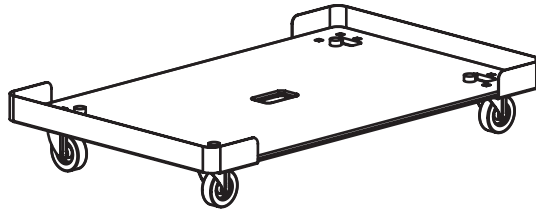

GDI-BNFIK

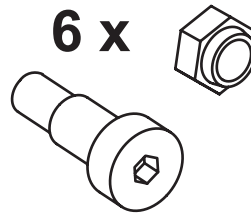

GDT-BKM

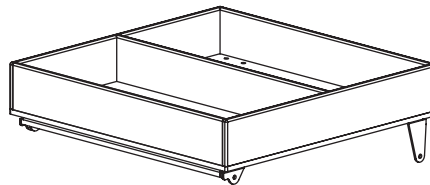

GDT-BTBUMPER

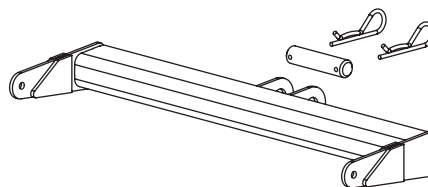

GDT-BUMPER

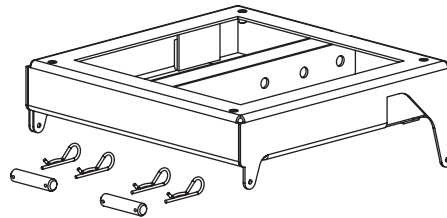

GDT-BUPDP

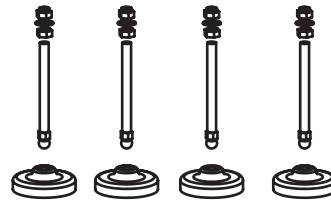

GDT-DCOVER3

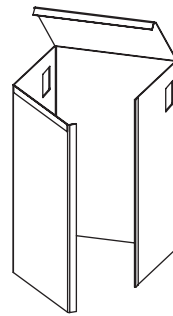

GDT-DCOVER4

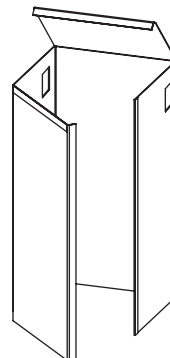

GDT-DOLLY

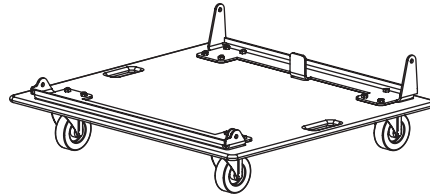

GDT-EXBAR1

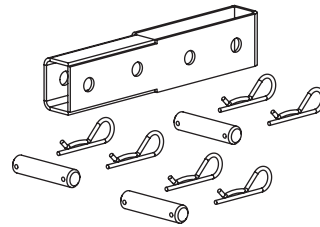

GDT-EXBAR2

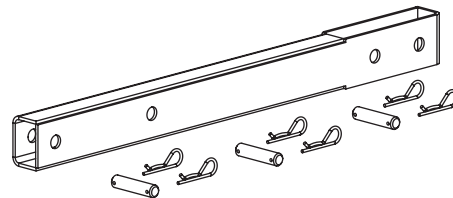

GDT-EXBAR3

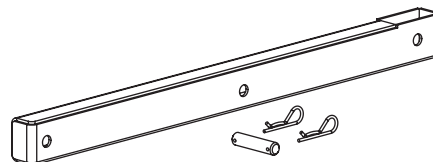

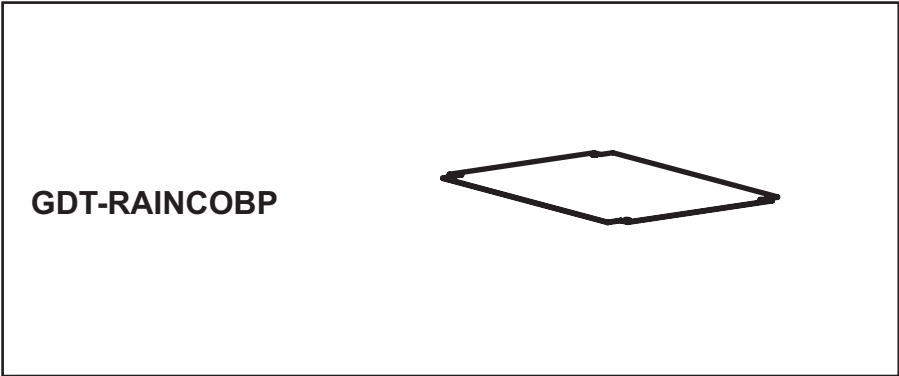
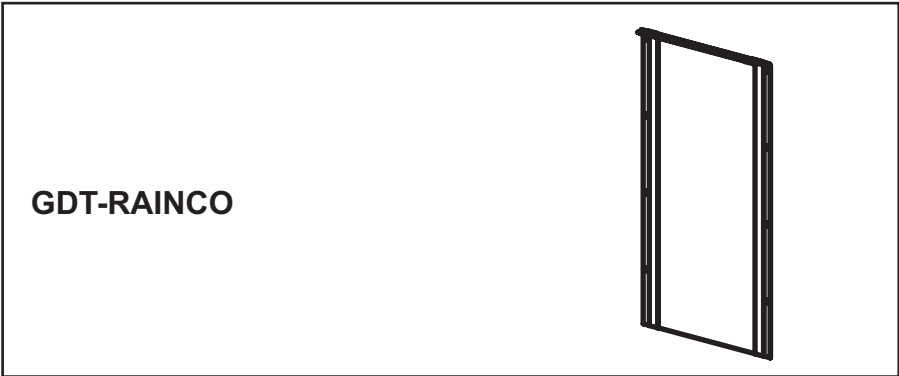
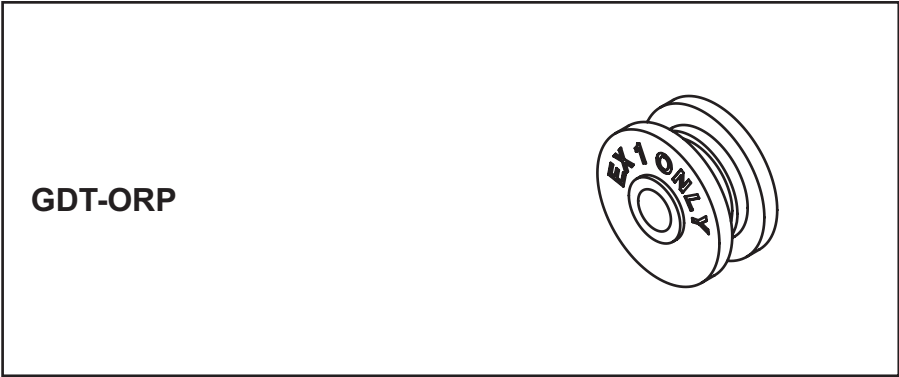
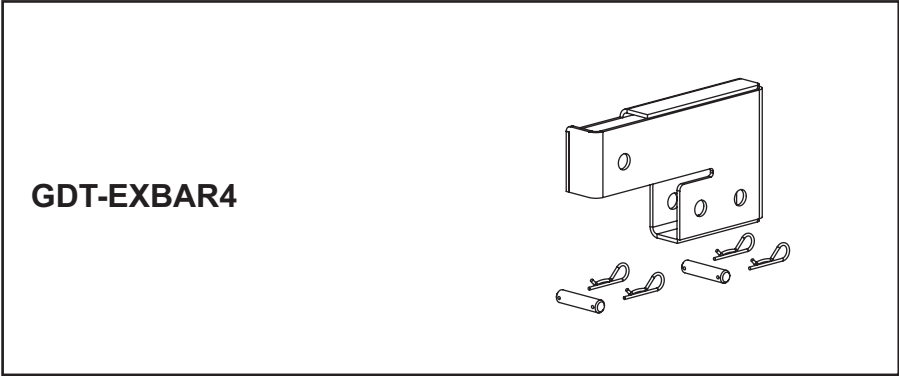

GDT-SUBCOVER

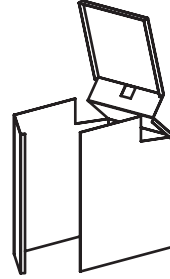

GDT-SUBDOLLY

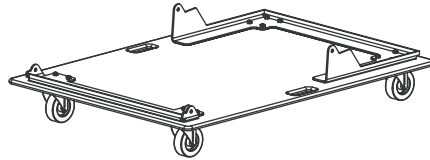

GPI-ANPL1

GPI-ANPL1PW

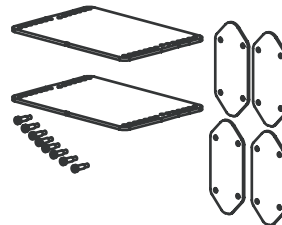

GPI-ANPL2

GPI-ANPL2PW

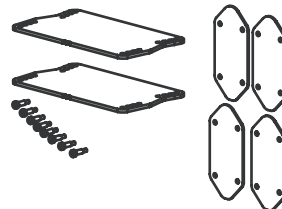

GPI-ANPL3
GPI-ANPL3PW

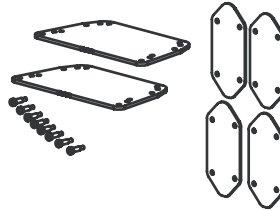

GPI-BUMPER
GPI-BUMPERPW

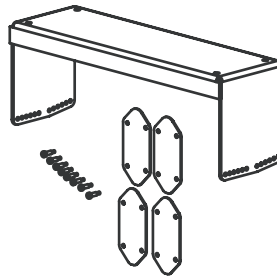

GPI-FLG

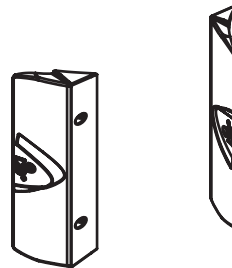

GPT-2CASE

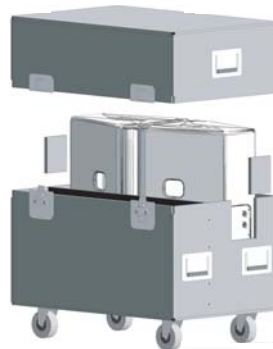

GPT-3CASE

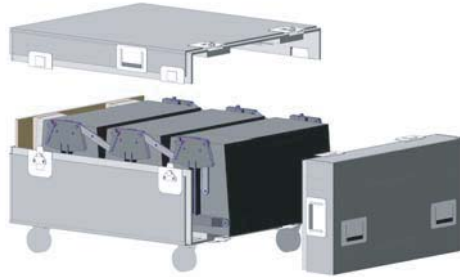

GPT-BCASE

GPT-BUMPER
GPT-BUMPERPW

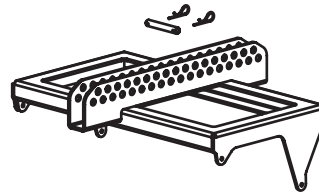

GPT-GSTK

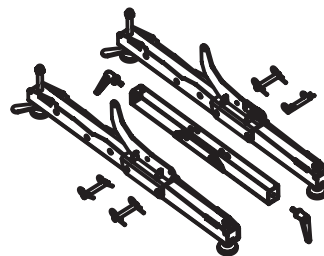

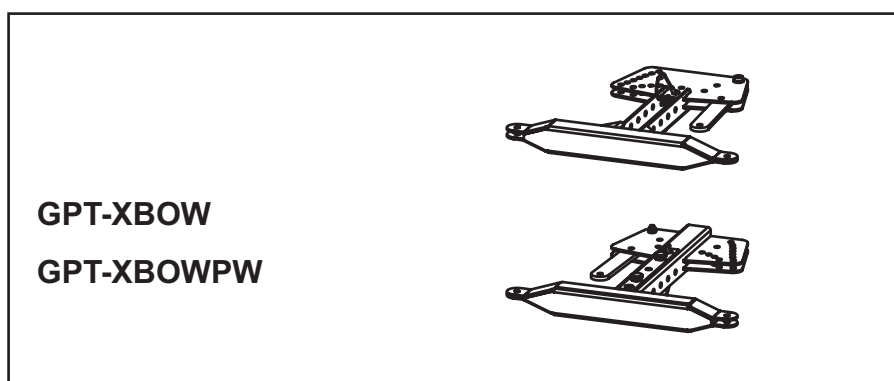
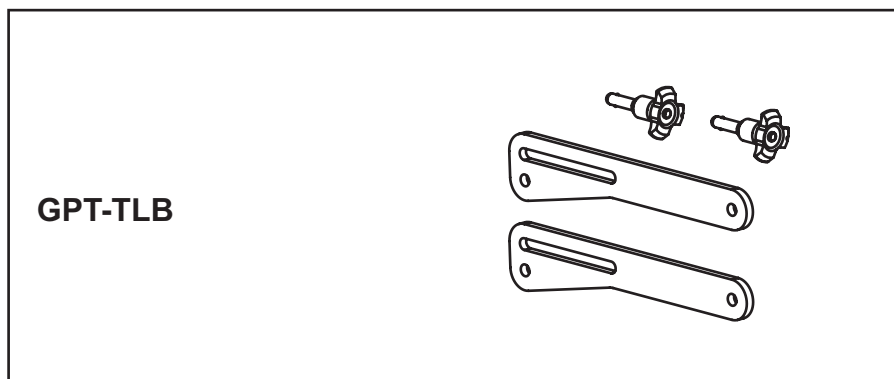
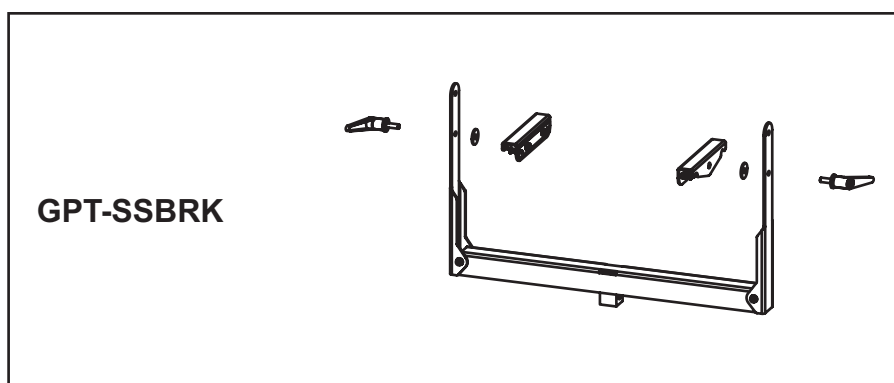
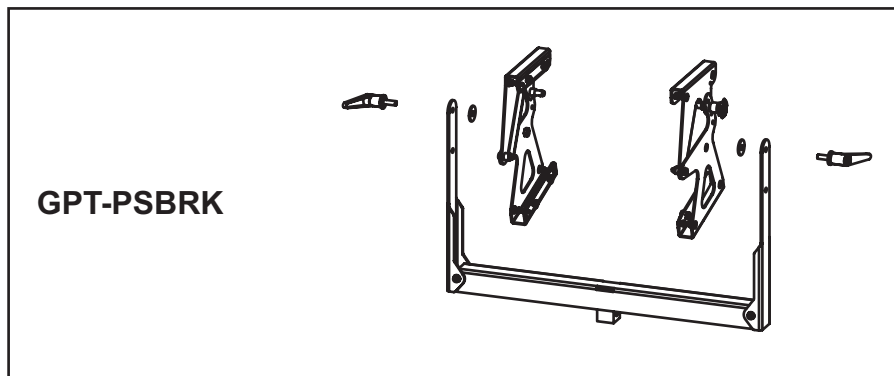

GST-7CASE

GST830CASE

GST-BUMPER
GST-BUMPERPW

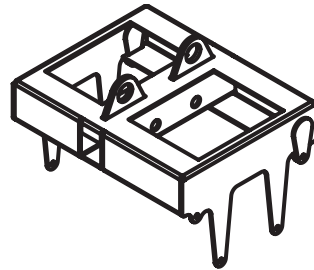

GST-EXBAR
GST-EXBARPW

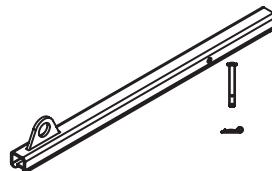

GST-GRND

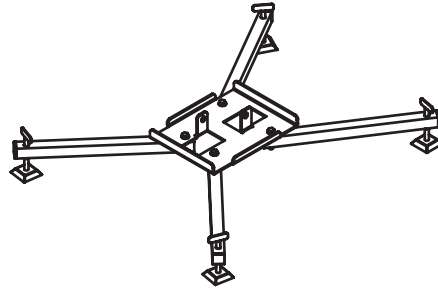

GST-HRPL

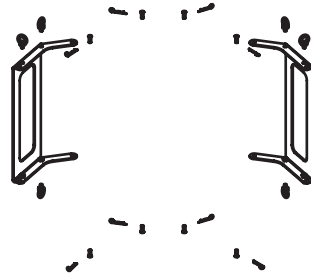

GTT-BCCH



GTT-BTBUMPER



GTT-BUMPER

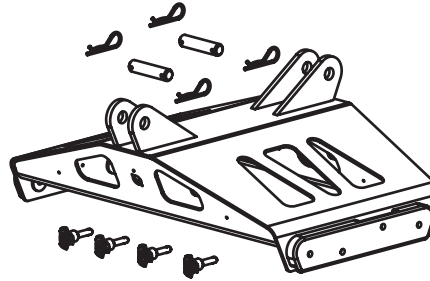

GTT-CASE

GTT-CASEEX3

GTT-KELPBEAM

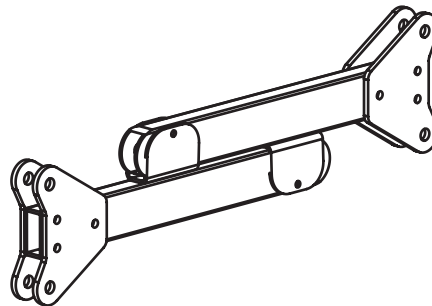

GTT-RAINCO

GTT-RAINCOBP

NAT-HAND4X1

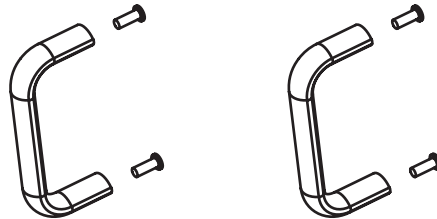

NAT-HAND4X4

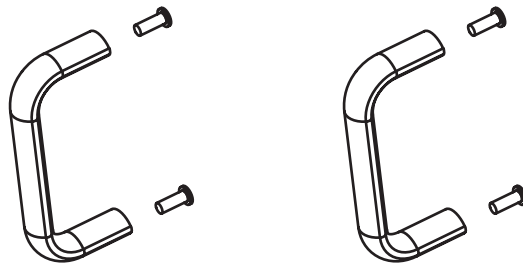

NAT-RSLV

RSI-INSP15

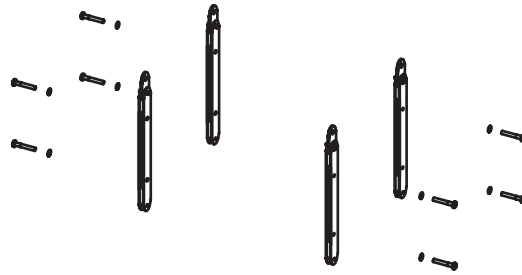

RST-BUMPER15

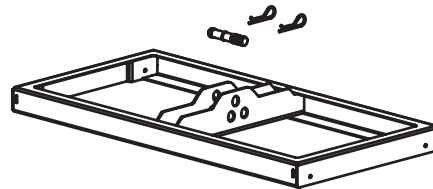

RST-DOLLY15

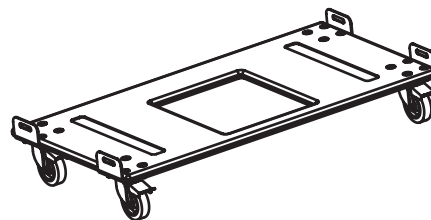

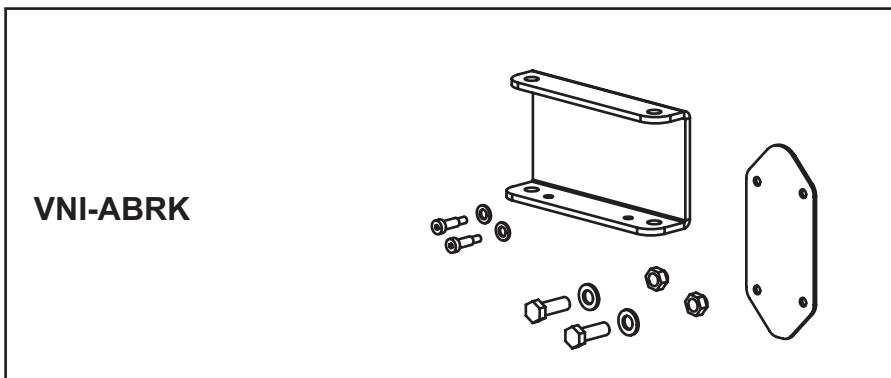
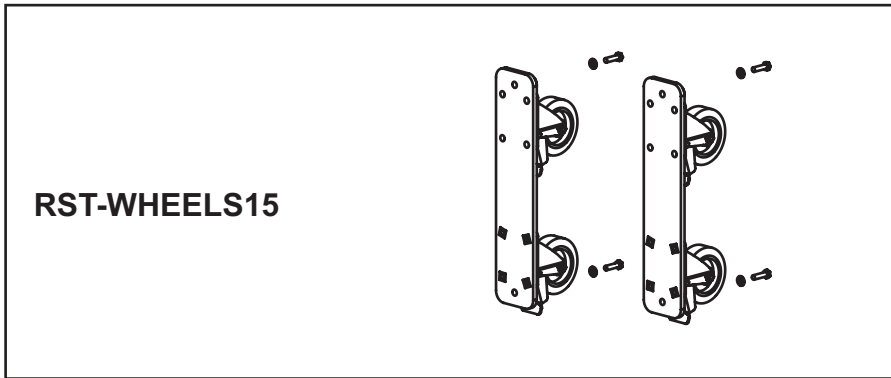
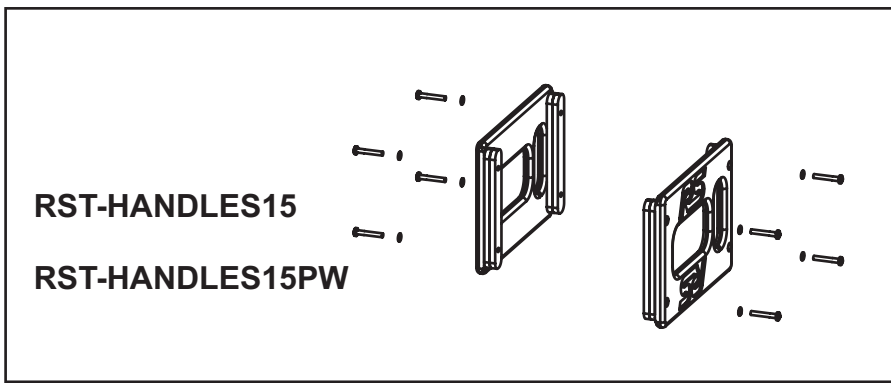
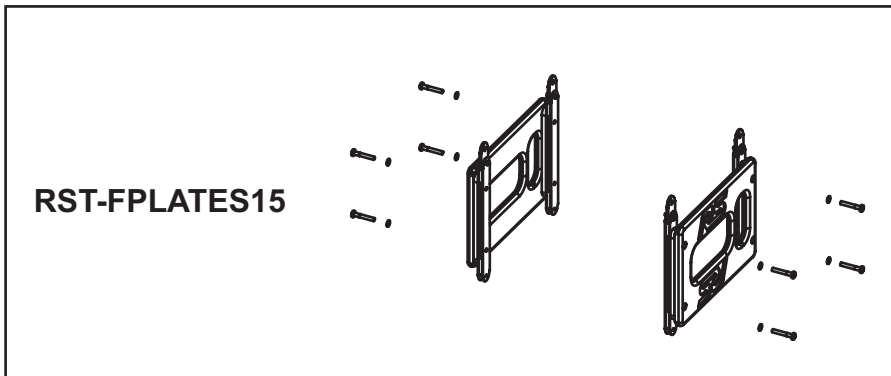

VNI-IPCOV8

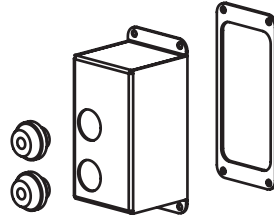

VNI-IPCOV15

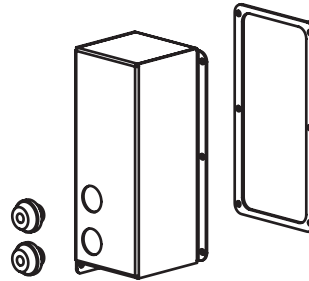

VNI-LBRK

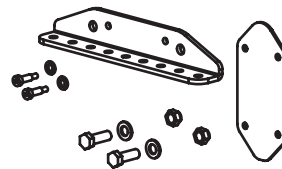

VNI-UBRK10

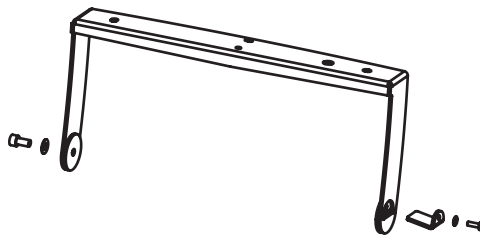

VNI-UBRK12

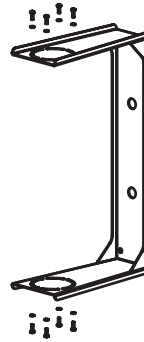

VNI-UBRK8



VNI-WS10
VNI-WS10PW

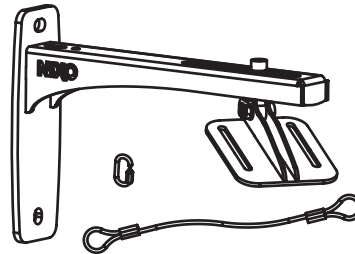

VNI-WS15
VNI-WS15PW

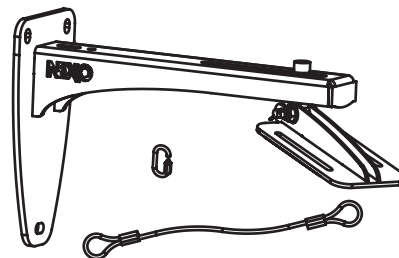

VNT-ADPT

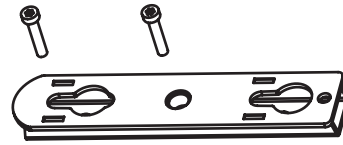

VNT-INCLST

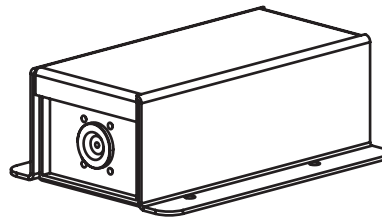

VNT-INCMMT



VNT-SSBRK10

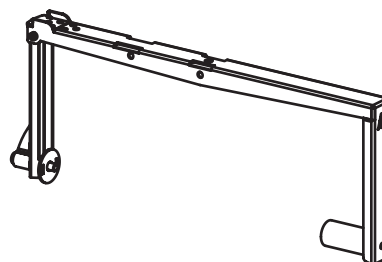

VNT-SSBRK15

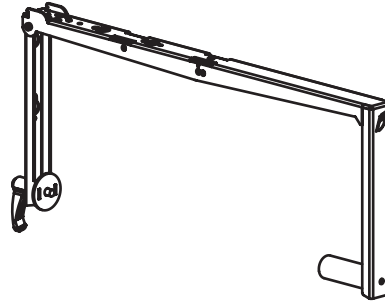

VNT-SSBRK8



VNT-TCBRK

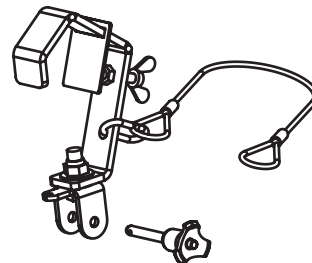

VNT-TTC

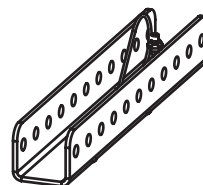

VNT-XHBRK

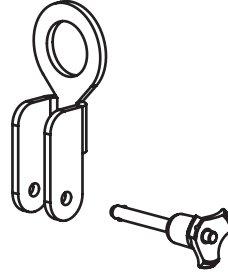

VXI-ADPT510

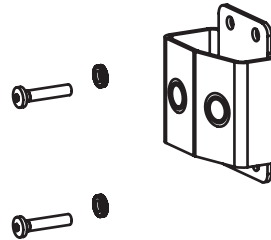

VXT-BL1020

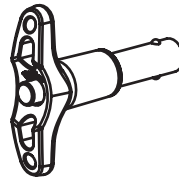

VXT-BL1230

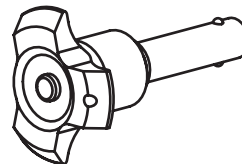

VXT-BL1235

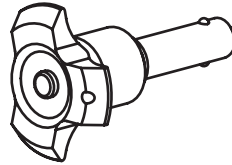

VXT-BL820

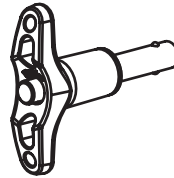

VXT-BL845

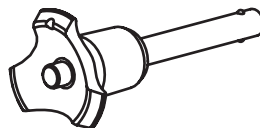

VXT-BLTRAP



VXT-BRIDLE2

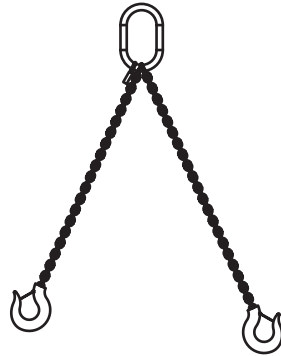

VXT-BRIDLE3

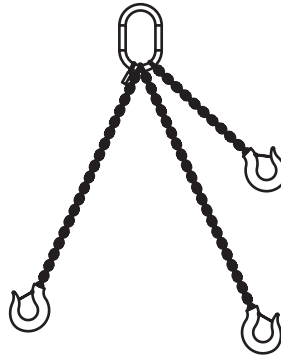

VXT-C30CT

VXT-C611F

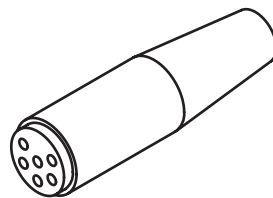

VXT-C612M

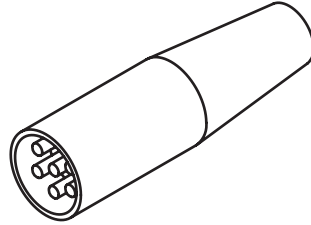

VXT-C613F

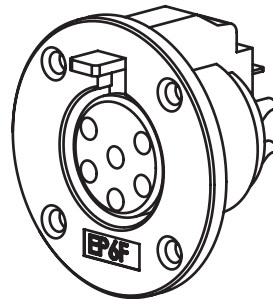

VXT-CCABLE

VXT-CHBAG



VXT-LEVA1500

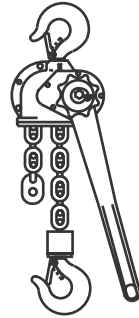

VXT-LEVA750

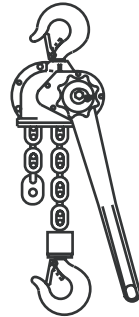

VXT-PLSTD

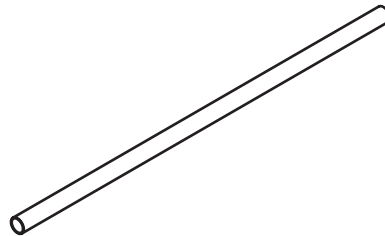

PST-FLYANCPS10



PST-FLYANSP



PSI-FLYCRA



PSI-FLYCRAPS10



PST-FLYLS

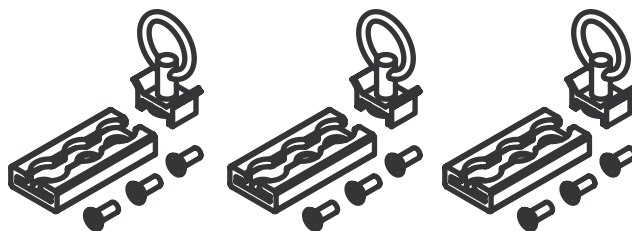

PST-FLYPS10

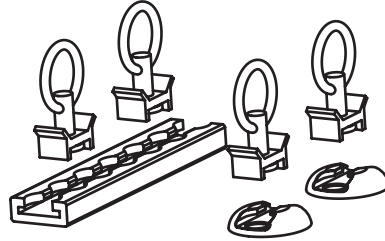

PST-FLYPS15

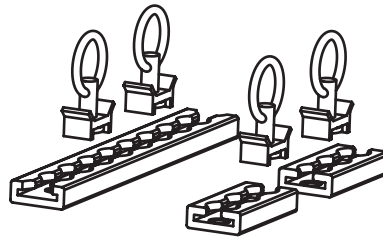

VNT-LBRK8

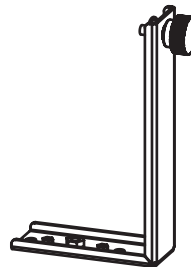

VNT-PSTAND8

