

A large circular graphic with a dark blue border and a maroon center. The background of the circle consists of a series of white, gear-like or saw-tooth shapes radiating from the center. The text 'PRODUCT CATALOG' is written in white, serif, all-caps font within the maroon circle.

PRODUCT
CATALOG

BSWA

TABLE OF CONTENTS

COMPANY INTRODUCTION

2-3 Company introduction

MICROPHONES

4-5 Microphones Overall Introduction

6-7 Prepolarized Microphones-Free Field

8-9 Prepolarized Microphones-Pressure Field & Diffuse Field

10-11 200V Polarized Microphones

12-13 Preamplifiers

14-15 MPA Series Microphones

16-17 MKV Series Microphones

18-19 Microphone Conditioning Units

20 Surface Microphone

21 TEDS Reader & Writer

22 Sound Intensity Probe

23 Outdoor Microphones

24 Studio Microphones

25 Sound Calibrators

26 High Sound Pressure Calibrator & Full Frequency Coupler

27 Electrostatic Actuator/Power/Calibration Stand

28 Microphone Arrays

29 Customized Microphone Arrays

30 Microphone Spherical Surface Fixture for Sound Power Testing

31 Turntable & D/A Converter for Digital Microphone Testing

REAL TIME ANALYZERS

32-33 Data Acquisition Hardware

34-35 VA-Lab Software

TABLE OF CONTENTS

MATERIAL TESTING DEVICES

36 Impedance Tube

37 Small Reverberation Chamber

AUDIO TESTING

38 Audio Testing Software

39 Artificial Ear & Mouth Simulators

40 Ear Speaker Testing Box

41 Loud Speaker Testing Box

42 Artificial Head

SOUND SOURCES

43 Mid-Frequency Volume Source

44 Omni-Sound Source & Power Amplifiers

45 Tapping Machine

SOUND LEVEL METER & DOSIMETER

46 Dosimeter

47 Sound Level Meter

OUTDOOR NOISE MONITORING

48 Outdoor Noise Monitoring Terminal

49 Outdoor Noise Monitoring Software

CABLES

50 Cables

ACCESSORIES

51 Accessories



Welcome to BSWA Product Catalogue which covers a full range of acoustic measurement devices. The products are sorted into easy-to-follow sections:

- Microphones
- Sound level meter
- Measuring systems
- Material testing
- Audio testing
- Outdoor monitoring systems
- Sound sources
- Cable and accessories

Established in 1998, BSWA Technology Co., Ltd. is becoming the preferred supplier for your acoustical measurements. With headquarter located in Beijing, BSWA currently employs 100 staffs with branch offices in Shanghai, Guangzhou, and Chengdu. BSWA's products are distributed in over 40 countries through our sales partners.

Production

BSWA's production facility is located 30 km from central Beijing and includes over 1200 m² of floor space. The facility comprises manufacturing areas, testing laboratories, environmental chambers, a full anechoic chamber, and a clean room. All products are individually tested to meet BSWA's high standards in quality and performance.

Quality

BSWA is fully committed to Quality Management ensuring that every product meets strict standards in performance. BSWA continues to invest in new machine tool technology, new methods of calibration, and new process control methods to further microphone and related equipment technology while reducing manufacturing costs. BSWA was awarded ISO9001 Certificate from TÜV in 2009.

Research & Development

As a technology-leading company, BSWA invests heavily in product research and development. BSWA hires skilled individuals, most with M.S. and Ph.D. degrees in acoustics and related sciences. This results in not only an incredibly knowledgeable team of developers and technicians, but also a team that is dynamic, highly motivated, and able to develop and manufacture high quality products.

BSWA is continuously improving its products while developing new ones in response to customer needs. From this new catalogue, you will find many new products such as ABox260 /380 for mobile phone testing; CA916 active coupler from microphone calibration; new features in AV-Lab software; CA111 new calibrator; BSWA308 sound level meter, and many more. BSWA strives for excellence in product design resulting in high quality and exceptional performance. The latest information about BSWA can be found at:

www.bswa-tech.com



2012

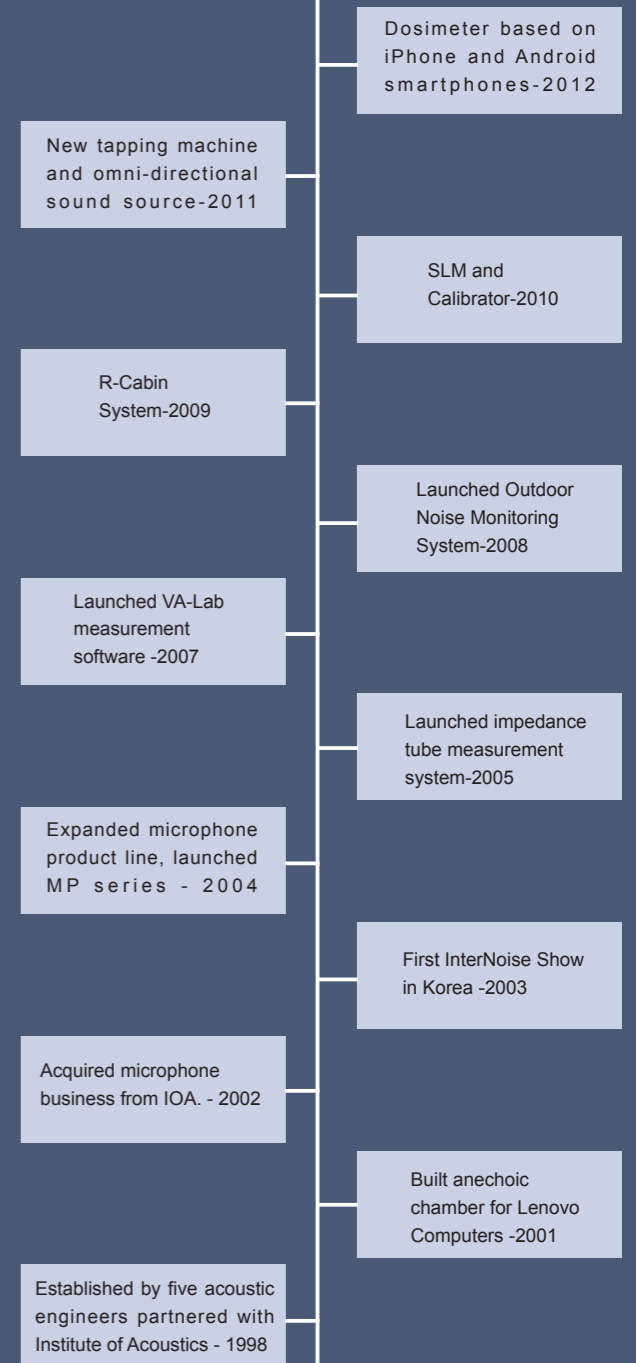

1998



MICROPHONES OVERALL INTRODUCTION

A microphone is an acoustic-to-electric transducer or sensor that converts sound into an electrical signal. Most microphones use the change of capacitance caused by the diaphragm mechanical vibration to produce an electrical voltage signal. In a condenser microphone, the diaphragm acts as one plate of a capacitor, and the vibrations produce changes in the distance between the plates. There are two types of microphones of this kind: Pre-polarized Microphones and 200V Polarized Microphones.

Pre-polarized Microphones

A nearly constant charge is maintained on the capacitor. As the capacitance changes, the charge across the capacitor does change very slightly, but at audible frequencies it is sensibly constant. Pre-polarized Microphones do not need a bias-voltage supply.

200V Polarized Microphones

There is no charge maintained on the capacitor, while there would be 200V bias-voltage between the plates. It would be necessary to have a 200V bias-voltage supply for the microphone. This type of microphone cannot tolerate high humidity. It is expected to be stored in the package to prevent humidity. But this type of microphone is much more stable and its operating temperature could reach up to 150 °C.

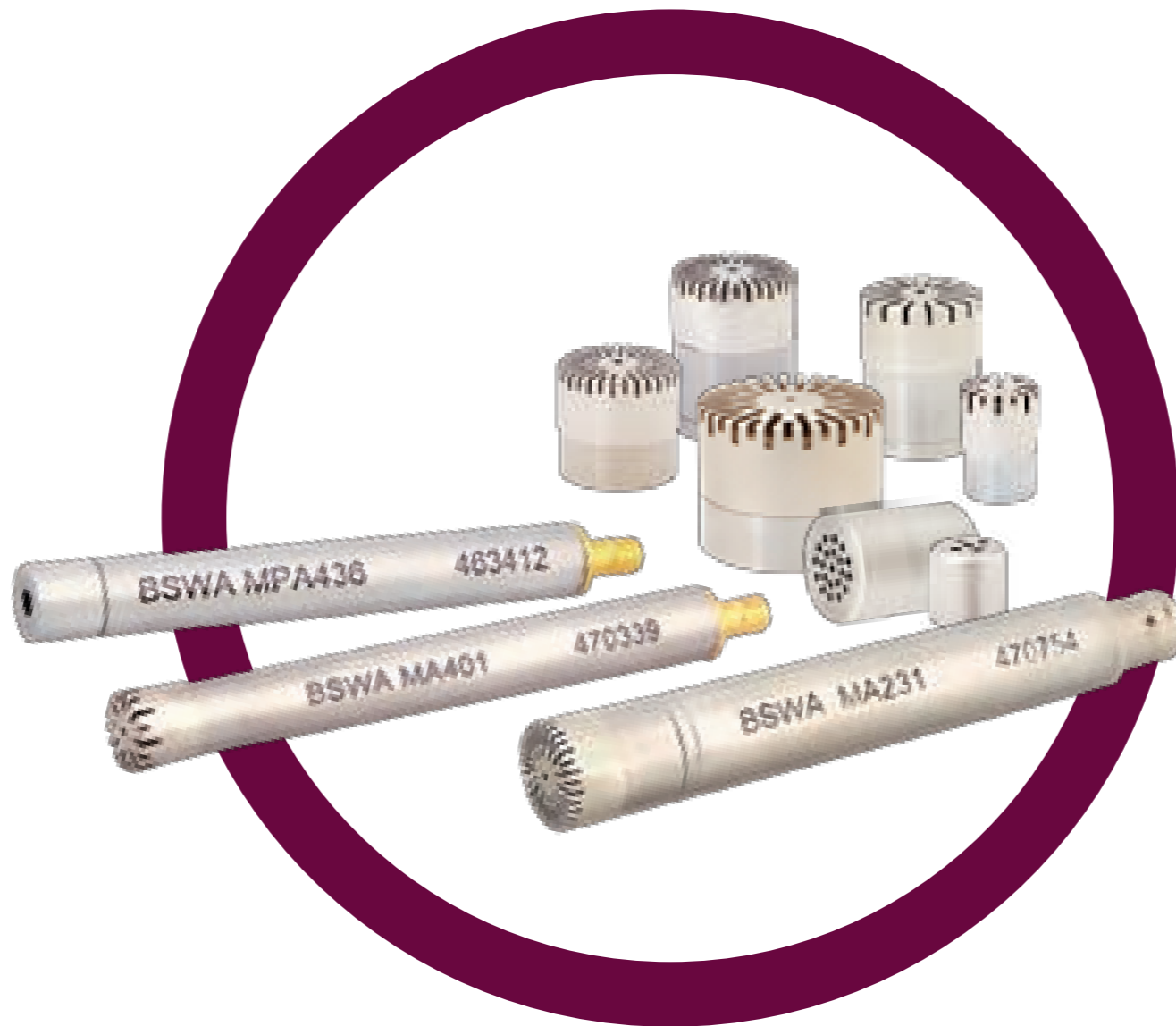

BSWA TECH

Measurement microphones can be divided into three groups: Free-field, Pressure-field, and Random-incidence.

The difference of the testing results by three types of measurement microphones would be smaller than 0.3 dB when the frequency to be measured is lower than 5000Hz; while the difference could be larger than 10 dB if the frequency to be measured is higher than 16000 Hz. So it is crucial to choose the right microphone to get an accurate measurement result.

Free-field Microphones

A microphone can change the sound field in which it is placed. A free-field microphone is designed to compensate for the influence of its presence in the sound field. So it can measure the sound pressure as it exists before the microphone is introduced into the sound field and can be used in such environments as outdoors, anechoic room, or reverberation room.

Pressure-field Microphones

A pressure-field microphone can measure the sound pressure existing on the diaphragm of the microphone. It can be used in a coupler environment such as an ear simulator or to test the sound pressure on a surface.

Random-incidence Microphones

Only ANSI standards request for random-incidence microphones. A random-incidence microphone may be required to make the measurements according to ANSI standards.



Prepolarized Microphones-Free Field

MP201 / MP231 / MP215 / MP216 / MP401 / MP411 / MP418

Model	MP201	MP231	MP215	MP216	MP401	MP411	MP418
Photos							
Optimized	Free-field	Free-field	Free-field	Free-field	Free-field	Free-field	Free-field
Diameter	1/2"	1/2"	1/2"	1/2"	1/4"	1/4"	1/4"
Standards (IEC61672)	Class I	Class I	Class II	Class II	Class I	Class I	Class II
Frequency Response (Hz)	6.3 ~ 20k	3 ~ 20k	20 ~ 12.5k	20 ~ 12.5k	10 ~ 70k	10 ~ 40k	20 ~ 16k
Open-circuit Sensitivity (mV/Pa) (±2dB)	50	40	40	32	5	2	10
Dynamic Range (dBA)	16 ~ 146	16 ~ 146	23 ~ 146	28 ~ 135	35 ~ 164	45 ~ 168	36 ~ 137
Inherent Noise (dBA)	< 16	< 16	< 23	< 28	< 35	< 45	< 36
Venting	Rear	Rear	Rear	Rear	Rear	Rear	Front
Operating Temperature (°C)	-30 ~ 80	-30 ~ 80	-20 ~ 80	0 ~ 40	-30 ~ 80	-30 ~ 80	0 ~ 40
Operating Humidity (RH) (Without Condensed Water)	0 ~ 98%	0 ~ 98%	0 ~ 98%	0 ~ 98%	0 ~ 98%	0 ~ 98%	0 ~ 98%
Capacitance (pF)	16	16	13	25	6	6	6
Equivalent Air Volume (mm ³)	40	40	45	60	0.6	0.6	1
Temperature Coefficient (dB/°C)	0.005	0.005	<± 0.3 dB (0 ~ 40 °C) with 250Hz, at reference temperature 23 °C	<± 0.6 (0 ~ 40 °C) with 250Hz, at reference temperature 23 °C	0.009	0.009	<± 0.6 (0 ~ 40 °C) with 250Hz, at reference temperature 23 °C
Humidity Coefficient (dB/%RH)	0.003	0.003	0.007	0.015	0.003	0.003	0.015
Pressure Coefficient (250 Hz) (dB/kPa)	-0.004	-0.004	-0.03	-0.06	-0.007	-0.007	-0.06
Dimensions	IEC 1094-4 Type WS2	IEC 1094-4 Type WS2	IEC 1094-4 Type WS2	IEC 1094-4 Type WS2	IEC 1094-4 Type WS3	IEC 1094-4 Type WS3	--
Screw Thread	M11.7 – 60UNS	M11.7 – 60UNS	M11.7 – 60UNS	M11.7 – 60UNS	M5.7 – 60UNS	M5.7 – 60UNS	M6 × 0.5
Matching Preamplifiers	MA231 / MA221 / MA231T	MA231 / MA221 / MA231T	MA231 / MA221 / MA231T	MA231 / MA221 / MA231T	MA401	MA401	MA408



Prepolarized Microphones-Pressure Field & Diffuse Field

MP251 / MP253 / MP451 / MP471 / MP281

Model	MP251	MP253	MP451	MP471	MP281
Photos					
Optimized	Pressure-field	Pressure-field	Pressure-field	Pressure-field	Random-incidence
Diameter	1/2"	1/2"	1/4"	1/4"	1/2"
Standards	Class I	Class I	Class I	Class I	ANSI Type I
Frequency Response (Hz)	8 ~ 20k	8 ~ 10k	10 ~ 50k	10 ~ 40k	6 ~ 12.5k
Open-circuit Sensitivity (mV/Pa) (±2dB)	10	50	4	2	40
Dynamic Range (dBA)	25 ~ 146	16 ~ 146	35 ~ 164	45 ~ 168	16 ~ 146
Inherent Noise (dBA)	< 25	< 16	< 35	< 45	< 16
Venting	Rear	Rear	Rear	Rear	Rear
Operating Temperature (°C)	-30 ~ 80	-30 ~ 80	-30 ~ 80	-30 ~ 80	-30 ~ 80
Operating Humidity (RH) (Without Condensed Water)	0 ~ 98%	0 ~ 98%	0 ~ 98%	0 ~ 98%	0 ~ 98%
Capacitance (pF)	12	16	6	6	16
Equivalent Air Volume (250 Hz) (mm ³)	30	40	0.6	0.6	40
Temperature Coefficient (dB/°C)	0.008	0.008	0.009	0.009	0.005
Humidity Coefficient (dB/%RH)	0.003	0.003	0.003	0.003	0.003
Pressure Coefficient (250 Hz) (dB/kPa)	-0.005	-0.005	-0.007	-0.007	-0.004
Dimensions	IEC 1094-4 Type WS2	IEC 1094-4 Type WS2	IEC 1094-4 Type WS3	IEC 1094-4 Type WS3	IEC 1094-4 Type WS2
Screw Thread	M11.7 – 60UNS	M11.7 – 60UNS	M5.7 – 60UNS	M5.7 – 60UNS	M11.7 – 60UNS
Matching Preamplifiers	MA231 / MA221 / MA231T	MA231 / MA221 / MA231T	MA401	MA401	MA231 / MA221 / MA231T





200V Polarized Microphones

MK101 / MK201 / MK401 / MK411 / MK253 / MK451

Model	MK101	MK201	MK401	MK411	MK253	MK451
Photos						
Optimized	Free-field	Free-field	Free-field	Free-field	Pressure-field	Pressure-field
Diameter	1"	1/2"	1/4"	1/4"	1/2"	1/4"
Standards (IEC61672)	Class I	Class I	Class I	Class I	Class I	Class I
Frequency Response (Hz)	3 ~ 16k	4 ~ 20k	4 ~ 70k	4 ~ 70k	4 ~ 10k	4 ~ 50k
Open-circuit Sensitivity (mV/Pa) (±2dB)	50	40	5	2	40	4
Dynamic Range (dBA)*	10 ~ 147	16 ~ 149	35 ~ 167	45 ~ 180	18 ~ 149	35 ~ 167
Inherent Noise (dBA)	< 10	< 16	< 35	< 45	< 18	< 35
Venting	Rear	Rear	Rear	Rear	Rear	Rear
Operating Temperature (°C)	-30 ~ 150	-30 ~ 150	-40 ~ 150	-40 ~ 150	-30 ~ 150	-40 ~ 150
Operating Humidity (RH) (Without Condensed Water)	0 ~ 90%	0 ~ 95%	0 ~ 95%	0 ~ 95%	0 ~ 95%	0 ~ 95%
Capacitance (pF)	66	16	6	6	16	6
Equivalent Air Volume (mm ³)	150	40	0.6	0.6	40	0.6
Temperature Coefficient (dB/°C)	0.002	0.007	0.009	0.009	0.007	0.009
Humidity Coefficient (dB/%RH)	0.004	0.003	0.003	0.003	0.004	0.003
Pressure Coefficient (250 Hz) (dB/kPa)	-0.02	-0.01	-0.007	-0.007	-0.01	-0.007
Dimensions	IEC 1094-4 Type WS1	IEC 1094-4 Type WS2	IEC 1094-4 Type WS3	IEC 1094-4 Type WS3	IEC 1094-4 Type WS2	IEC 1094-4 Type WS3
Screw Thread	M23.11 – 60UNS	M11.7 – 60UNS	M5.7 – 60UNS	M5.7 – 60UNS	M11.7 – 60UNS	M5.7 – 60UNS
Matching Preamplifiers	MV201	MV201	MV401	MV401	MV201	MV401

BSWA



The upper-limit of the dynamic range of the 200V-polarized-microphones depends on the preamplifier supply voltage. For example, the upper-limit of the MK101 is 147 dB if the supply voltage of its preamplifier is 120V



Preamplifiers

MA231 / MA221 / MA231T / MA401 / MA418 / MV201 / MV401

Model	MA231	MA221	MA231T	MA401	MA418	MV201	MV401
Photos							
Diameter	1/2"	1/2"	1/2"	1/4"	1/4"	1/2"	1/4"
Frequency Response (Hz) (± 0.5 dB)	19 ~ 150k	19 ~ 150k	19 ~ 150k	19 ~ 150k	19 ~ 150k	1 ~ 1M	1 ~ 1M
Attenuation (dB) (10 Hz ~ 100k Hz)	< 0.1	< 0.1	< 0.1	< 0.1	< 0.1	< 0.5	< 0.5
Input Impedance ($G\Omega$ pF)	20 0.1	20 0.1	20 0.1	20 0.2	20 0.2	10 0.2	10 0.2
Output Impedance (Ω)	< 50	< 50	< 50	< 50	< 50	< 80	< 100
Inherent Noise	A Weighted < 3 μ V 20 Hz ~ 20k Hz < 5 μ V	A Weighted < 3 μ V 20 Hz ~ 20k Hz < 5 μ V	A Weighted < 3 μ V 20 Hz ~ 20k Hz < 5 μ V	A Weighted < 3 μ V 20 Hz ~ 20k Hz < 5 μ V	A Weighted < 3 μ V 20 Hz ~ 20k Hz < 5 μ V	A Weighted (20 pF) < 5 μ V Z Weighted (20 pF) < 10 μ V	A Weighted (20 pF) < 5 μ V Z Weighted (20 pF) < 20 μ V
Max. Output Voltage (Vrms)	5	5	5	5	5	23	23
Supply Power	ICCP (2 ~ 20 mA)	ICCP (2 ~ 20 mA)	ICCP (2 ~ 20 mA)	ICCP (2 ~ 20 mA)	ICCP (2 ~ 20 mA)	28 - 120 VDC	28 - 120 VDC
Operating Temperature ($^{\circ}$ C)	-40 ~ 80	-40 ~ 80	-40 ~ 80	-40 ~ 80	-40 ~ 80	-10 ~ 50	-10 ~ 50
Operating Humidity (RH)	0 ~ 95%	0 ~ 95%	0 ~ 95%	0 ~ 95%	0 ~ 95%	0 ~ 95%	0 ~ 95%
Dimensions	$\varnothing 12.7 \times 74$ mm	$\varnothing 12.7 \times 31.7$ mm	$\varnothing 12.7 \times 90$ mm	$\varnothing 7 \times 56$ mm	$\varnothing 7 \times 56$ mm	$\varnothing 12.7 \times 86.6$ mm	$\varnothing 6.3 \times 63$ mm
Connector	BNC	SMB	TNC	SMB	SMB	7-pin LEMO	7-pin LEMO
Screw Thread	M 11.7 mm \times 60 UNS	M 11.7 mm \times 60 UNS	M 11.7 mm \times 60 UNS	M 5.7 mm \times 60 UNS	M 6 mm \times 0.5 UNS	M 11.7 mm \times 60 UNS	M 5.7 mm \times 60 UNS

Notice: ICCP = Integrated Constant Current Power

MPA Series Microphones

MPA201 / MPA231 / MPA215 / MPA416 / MPA436 / MPA418 / MPA401

Model	MPA201	MPA231	MPA215	MPA416*	MPA436*	MPA418	MPA401
Photos							
Diameter	1/2"	1/2"	1/2"	1/4"	1/4"	1/4"	1/4"
Standards (IEC61672)	Class I	Class I	Class II	Class I	Class I	Class II	Class I
Microphone	MP201	MP231	MP215	Integrated	Integrated	MP418	MP401
Optimized	Free Field	Free Field	Free Field	Free Field	Free Field	Free Field	Free Field
Preamplifier	MA231(TEDS optional)	MA231(TEDS optional)	MA231(TEDS optional)	Integrated	Integrated	MA418	MA401
Frequency Response (Hz)	20 ~ 20k	20 ~ 20k	20 ~ 12.5k	20 ~ 20k	20 ~ 20k	20 ~ 16k	20 ~ 70k
Open-circuit Sensitivity (mV/Pa) (± 2 dB)	45	40	40	50	12.5	10	5
Output Impedance (Ω)	< 50	< 50	< 110	< 110	< 110	< 110	< 110
Dynamic Range (dBA)	16 ~ 134	17 ~ 136	23 ~ 135	29 ~ 127	35 ~ 130	36 ~ 135	35 ~ 155
Inherent Noise (dBA)	< 16	< 17	< 23	< 29	< 35	< 36	< 35
Operating Temperature ($^{\circ}$ C)	-30 ~ 80	-30 ~ 80	-20 ~ 80	-10 ~ 50	-10 ~ 50	0 ~ 40	-20 ~ 80
Operating Humidity (RH)	0 ~ 95%	0 ~ 95%	0 ~ 95%	0 ~ 95%	0 ~ 95%	0 ~ 98%	0 ~ 98%
Temperature Coefficient (dB/ $^{\circ}$ C)	0.005	0.005	$\leq \pm 0.3$ dB (0 ~ 40 $^{\circ}$ C) with 250Hz, at reference temperature 23 $^{\circ}$ C	15 ~ 35 $^{\circ}$ C: $\leq \pm 0.3$ dB; 0 ~ 40 $^{\circ}$ C: $\leq \pm 1.5$ dB; -10 ~ 50 $^{\circ}$ C: $\leq \pm 3.0$ dB; with 1000Hz, at reference temperature 23 $^{\circ}$ C	23 $^{\circ}$ C(15 ~ 35 $^{\circ}$ C): $\leq \pm 0.3$ dB; 0 ~ 40 $^{\circ}$ C: $\leq \pm 1.5$ dB;-10 ~ 50 $^{\circ}$ C: $\leq \pm 3.0$ dB; with 1000Hz, at reference temperature 23 $^{\circ}$ C	$\leq \pm 0.6$ (0 ~ 40 $^{\circ}$ C) at reference temperature 23 $^{\circ}$ C	-0.009
Humidity Coefficient (dB/%RH)	0.003	0.003	0.007	20% ~ 90% RH: $\leq \pm 0.8$ dB with 1000Hz, at reference temperature 23 $^{\circ}$ C, Humidity 50% RH	20% ~ 90% RH: $\leq \pm 0.8$ dB with 1000Hz, at reference temperature 23 $^{\circ}$ C, Humidity 50% RH	0.015	0.003
Pressure Coefficient (250 Hz) (dB/kPa)	-0.004	-0.004	-0.03	-0.06	-0.06	-0.06	-0.007
Length (mm)	91	91	91	61	24	64	67
Input Connector	BNC	BNC	BNC	SMB	SMB	SMB	SMB
Corresponding Model with TEDS	MPA261	MPA271	MPA265	MPA466	--	--	--

*The MPA416 & MPA436 are the most suitable models for array uses. The frequency responses meet the IEC 61672 Class 1 requirements.



MKV Series Microphones

MKV101 / MKV201 / MKV401 / MKV411 / MKV253 / MKV451

Model	MKV101	MKV201	MKV401	MKV411	MKV253	MKV451
Photos						
Diameter	1"	1/2"	1/4"	1/4"	1/2"	1/4"
Standards (IEC61672)	Class I	Class I	Class I	Class I	Class I	Class I
Microphones	MK101	MK201	MK401	MK411	MK253	MK451
Optimized	Free Field	Free Field	Free Field	Free Field	Pressure Field	Pressure Field
Preamplifiers	MV201(with adaptor)	MV201	MV401	MV401	MV201	MV401
Frequency Response (Hz)	3 ~ 16k	4 ~ 20k	4 ~ 70k	4 ~ 70k	4 ~ 10k	4 ~ 70k
Open-circuit Sensitivity (mV/Pa) (± 2 dB)	50	40	5	2	40	4
Output Impedance (Ω)	< 80	< 80	< 100	< 100	< 80	< 100
Dynamic Range (dBA)	14 ~ 147	16 ~ 149	35 ~ 146	45 ~ 180	18 ~ 149	35 ~ 167
Inherent Noise (dBA)	< 14	< 16	< 35	< 45	< 18	< 35
Operating Temperature ($^{\circ}$ C)	-10 ~ 50	-10 ~ 50	-10 ~ 50	-10 ~ 50	-10 ~ 50	-10 ~ 50
Operating Humidity (RH) (without condensed water)	0 ~ 90%	0 ~ 90%	0 ~ 90%	0 ~ 90%	0 ~ 90%	0 ~ 90%
Temperature Coefficient (dB/ $^{\circ}$ C)	0.002	0.007	0.009	0.009	0.007	0.009
Humidity Coefficient (dB/RH)	0.004	0.003	0.003	0.003	0.004	0.003
Pressure Coefficient (250 Hz) (dB/kPa)	-0.02	-0.01	-0.007	-0.007	-0.01	-0.007
Microphone Length (mm)	110	105	73	73	105	73
Connector	7-pin LEMO	7-pin LEMO	7-pin LEMO	7-pin LEMO	7-pin LEMO	7-pin LEMO
Cable Length (m)	2	2	2	2	2	2
Matching Power Supply	MC711 / MC722	MC711 / MC722	MC711 / MC722	MC711 / MC722	MC711 / MC722	MC711 / MC722
Corresponding Model with TEDS	MKV161	MKV261	--	--	MKV263	--

BSWA



Microphone Conditioning Units

MC102 / MC141 / MC104 / MC711 / MC722

Model	MC102	MC141	MC104	MC711	MC722
Photos					
Number of Input Channels	2	1	4	1	2
Connector of Input	BNC	BNC	BNC	7-pin LEMO	7-pin LEMO
Number of Output Channels	2	1	4	1	2
Connector of Output	BNC	BNC	BNC	BNC	BNC
Frequency Response (Hz)	5 ~ 200k	5 ~ 200k	5 ~ 200k	1 ~ 1M	5 ~ 200k
Gain	--	× 1 , × 10	× 0.1 , × 1 , × 10	--	-20 dB, 0 dB, 20 dB, 40dB
Polarization Voltage	0 V	0 V	0 V	200 V or 0 V	200 V or 0 V
Output Power for Preamp	4 mA	4 mA	4 mA	28 V	28 V or 120 V
Power Supply	1 × 9 V Battery or 220 V	220 V	220 V	220 V	220 V
Filter	--	--	--	--	Lin, AW, HP, Dir
Operating Temperature (°C)	-10 ~ 50	-10 ~ 50	-10 ~ 50	-10 ~ 50	-10 ~ 50
Operating Humidity (RH)	0 ~ 95%	0 ~ 95%	0 ~ 95%	0 ~ 95%	0 ~ 95%
Dimension (mm)	113 × 70 × 45	113 × 70 × 45	310 × 250 × 65	113 × 70 × 45	260 × 60 × 150
Weight (g)	160	160	1500	190	1130





MPA426 is a low-cost surface microphone for aerodynamic noise measurements. It is widely used in ground vehicle and aerospace to investigate the wind induced noise. It can be easily mounted on surfaces using double sided adhesive tape.

The MPS426 has ICCP preamplifier and can be connected to any ICCP input channel. It has 5 m cable with SMB connector.

The MPS426 has a high sensitivity of 50mV/Pa and a flat frequency response between 20 Hz and 20 kHz.

The TEDS version of MPS426 is also available. It has a built-in TEDS chip written with such information as model, serial number, sensitivity, reference frequency, and etc.

SPECIFICATIONS

Surface Microphone & Probe Microphone	
Model	Surface Microphone MPS426
Front Microphone	--
Optimized	Free Field
Open-circuit Sensitivity	-26 dB ± 2 dB
Inherent Noise	29 dBA
Dynamic Range	127 dB
Frequency Response	20 Hz ~ 20k Hz
Power Supply	ICCP
Operating Temperature	-10 ~ 50
Diameter	60 mm
Thickness	7.5 mm
The length of cable	5 m
Calibration level	113.8 dB with CA 111 and adaptor
Front probe	--
Connector	SMB

TEDS stands for the Transducer Electronic Data Sheet as defined in IEEE 1451.4 standard.

BSWA TEDS Reader and Writer TR100 are designed especially for TEDS Microphones that meet IEEE 1451.4 standard. TR100 can read, write and rewrite the information in the TEDS microphones.

TR100 Features

- Compatible with IEEE1451.4 standard
- Support Template 27 (Microphones with built-in preamplifier)
- USB connector
- Identify TEDS chips automatically.

TR100 can read and write the following electronic data

- Manufacturer ID
- Product Type #, Serial #, and Version #
- Sensitivity (mV/Pa)
- Reference Frequency (Hz)
- Polarization Type (Prepolarization or 28V/200V)
- Microphone Type (Free-field, Pressure-field, Diffuse-field, and others)
- Microphone Diameter (1", 1/2", 1/4", 1/8")
- Equivalent Air Volume
- Polarity
- Calibration Information (Calibration date and period of validity)

BSWA TEDS Microphones are with the combination of BSWA ICCP microphones and TEDS preamplifiers. TEDS microphones help to facilitate plug and play and shorten system's setup time.

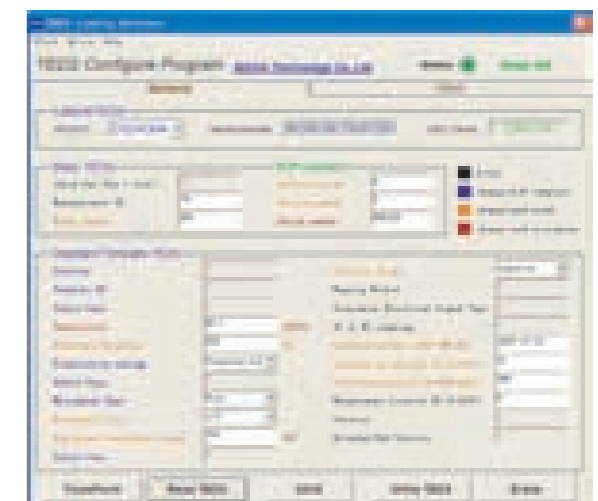



SI512 Sound Intensity Probe is built using ICCP type preamplifiers. SI512 is fitted with remote-control functions. It complies with IEC 1043 Class 2 Standard. Based on the technique of simultaneous determination of sound pressure and particle velocity by two closely spaced microphones, SI512 can be directly connected to ICCP inputs. With an USB end connected to the PC, SI512 can be remotely controlled to perform sound intensity measurements.

FEATURES

- ICCP® powered
- Remote-control functions
- Two BNC connectors for easy connection
- Accurate phase matched microphones
- Face to face configuration
- 1/3-octave centre frequency ranges: 63 Hz to 5 kHz
- Well-defined acoustical microphone separation.

SI512 comprises a robust frame which holds two ICCP preamplifiers and matched microphones in a face-to-face configuration. The distance between microphones is defined by solid, plastic spacers. Sound is constrained to act on each microphone through a narrow slit between the spacer and the microphone grid. This gives well-defined acoustic separation of the microphones and minimizes shadow and reflection effects.

Phase matching of 1/2"Microphone Pair selected from Type MP231 is better than 2 degrees in full test frequency range from 45 Hz to 6000 Hz. The normalized microphone frequency responses differ by less than 0.5 dB. SI512 is supplied with 8.5 mm, 12 mm and 50 mm spacers.

Each probe is individually calibrated in the anechoic chamber; the calibration data include phase matching, microphone sensitivities and actuator responses.



SPECIFICATIONS

Sound Intensity Probe SI512	
Standard	IEC 1043 Class 2
Frequency Range (1/3 Octave)	8.5 mm Spacer: 250 Hz ~ 5000 Hz 12 mm Spacer: 160 Hz ~ 5000 Hz 50 mm Spacer: 63 Hz ~ 1250 Hz
Weight	0.4 kg
Output Connectors	7-pin Lemo in the Probe
Cable to ICCP inputs	5 m cable with Lemo to 2 BNC connectors
Case Dimensions	400 x 200 x 70 mm
Microphone Pairs	
Microphones	Selected Type 1 MP231 for intensity microphone pair
Preamplifier	BSWA Type MA221 preamplifier
Diameter	1/2 inch
Response	Free Field
Combined Sensitivity	40 mV/Pa
Microphone Phase Response Difference	<0.3°, 45 Hz ~ 500 Hz <1°, 500 Hz ~ 2500 Hz <2°, 2500 Hz ~ 6000 Hz
Amplitude Response Difference (Ref 250 Hz)	< 0.5 dB ; 45 Hz ~ 6000 Hz
Equivalent Air Volume(250 Hz)	46 mm ³
Temperature Coefficient (-10 ~ 50)	-0.005 dB/
Humidity Coefficient	-0.003 dB/%RH
Pressure Coefficient (250 Hz)	-0.004 dB/kPa
Dimensions	IEC61094-4 Type WS 2

The remote-control function of SI512 can comply directly with such intensity system as BSWA, Müller-BBM, and etc.

Outdoor microphones are for outdoor uses such as the outdoor acoustic measurement or community and traffic noises monitoring. BSWA outdoor microphones are fitted with a windscreen, a rain protection, and a bird spike to protect them from wind, rain, snow and other atrocious weather. An adaptor pole is also included in the package which helps to connect the outdoor microphone to a camera and which also plays a role for protecting the cable.

BSWA outdoor microphones can be calibrated by a pistonphone by removing the windscreen and the rain protection.

The directional angle is 0° for airport noise monitoring and 90 ° for community and traffic noises monitoring.



OM231 is 1/2 inch prepolarized condenser outdoor microphone. It is suitable for use in rainy days or in an environment at very high or very low temperature. OM231 uses IEC 61672 CLASS 1 measurement microphone which is outstanding for its stability. It is the best choice for permanent outdoor use such as the airport noise monitoring.

OM416 is a low-cost outdoor microphone. It uses 1/4" ICCP microphone, which makes it suitable for 0° and 90 ° measurements. The OM416 is designed with disposable microphone concept. The microphone is easily removed and replaced after about six months of outdoor uses.

SPECIFICATIONS

Outdoor Microphones		
Model	OM231	OM416
Sensitivity	40 mV/Pa	50 mV/Pa
Microphone Diameter	1/2"	1/4"
Frequency Response	20 Hz ~ 20 kHz	20 Hz ~20 kHz
Dynamic Range (3% Distortion Limit)	17 ~136 dB	29 ~127 dB
Polarization Voltage	0 V	0 V
Power Supply	4 mA	4 mA
Calibration Sound Press Level	94 dB	94 dB
Reference direction	0° or 90°	0° or 90°
Output Connector	BNC	SMB
IEC 61672	Class 1	Class 2
Temperature ()	-30 ~ 80	-10 ~ 50
Humidity (RH)	0 ~ 95%	0 ~ 95%



BSWA SM4000 series phantom powered studio microphones are for precision recording and measurement of sound with no color added. They can be used to record essentially any instrument for a truly accurate representation of the original sound. Each SM4000 microphone is supplied with its individual calibration chart with frequency response and sensitivity data. Its modular design allows the preamplifier to be used with any of the high quality BSWA microphone capsules.

SM4201 microphone is top of the line. It is suitable for the most critical recording applications requiring extreme performance and environmental stability. Its nickel alloy construction ensures durability and outstanding performance. The electronic circuitry coupled with a transformerless output stage provides a flat frequency response across the entire audio bandwidth while at the same time achieving an extremely low noise floor.

SM4215 microphone is a top performer that uses the same preamplifier as the SM4201. It has the same flat frequency response out to 12.5 kHz stemming from its nickel alloy diaphragm. It is a great choice for accurate acoustic recording requiring a large dynamic range.



SM4216 microphone offers an economical choice with incredible performance. Its polymer diaphragm and copper housing yields a flat frequency response out to 16 kHz with excellent dynamic range and low noise floor. It is a proven performer for the price.

SM4418 microphone is 1/4" recording microphone. It has a flat frequency response out to 16 kHz with excellent dynamic range and low noise floor. Its impulse response and polymer diaphragm settling time is exceptional. Its sound is uncolored and it has no handling noise.

SPECIFICATIONS

Studio Microhones				
Model	SM4201	SM4215	SM4216	SM4418
Microphone Capsule	MP201	MP215	MP216	MP418
Linear Frequency Range	20 Hz ~ 20 kHz	20 Hz ~ 12.5 kHz	20 Hz ~ 16 kHz	20 Hz ~ 16 kHz
Sensitivity	40 mV/Pa	30 mV/Pa	25 mV/Pa	8 mV/Pa
Max. SPL for 3% THD	130 dB	130 dB	135 dB	135 dB
Equivalent Noise Level	18 dB (A)	25 dB (A)	21 dB (A)	32 dB (A)
Output Impedance	200 Ω			
Max. Output Voltage	4.5 Vrms (load > 2000 Ω); 1.0 Vrms (load =1000 Ω)			
Connector	XLR			
Phantom Power	25 V ~ 48 V (current 3 mA)			
Weight	160 g			
Polar Pattern	Omni Directional			
Modular parts				
SMA4000P	Phantom Powered Preamplifier for SM4000 Series Microphones			
SM4000 K	Microphone Kit includes SMA 4000P, MP201, MP215, and MP216			

CA111/CA114/CA115 is small sound source for calibrating measurement microphones, sound level meters, and other sound measurement equipments. The calibrator can be used on 1/2-inch and 1/4-inch microphones with adaptor.

CA111 conforms to IEC 60942:2003 Class 1, ANSI S1.40-1984 and GB/T 15173-1994.

CA114/115 conforms to IEC 60942:2003 Class 2 standards.



APPLICATIONS

- Calibration of measurement microphones, sound level meters, and other sound measurement equipments.
- Checking the linearity of equipments.

FEATURES

- Conforms to IEC60942:2003 Class 1/Class 2, ANSI S1.40-1984, and GB/T 15173-1994.
- 1 kHz calibration frequency for all weighting networks.
- CA111: Dual 94 & 114 dB sound pressure level outputs.
- CA114: 94 dB sound pressure level outputs.
- CA115: 114 dB sound pressure level outputs.
- Calibration accuracy ± 0.3 dB.
- Designed with highly stable level and frequency.
- CA111 for two-keypad operation and CA114/115 for one-keypad operation.
- Fits 1/2" microphones and 1/4" microphones with adaptor.
- Powered by 2×AAA battery and automatic power off to conserve battery life.

SPECIFICATIONS

Sound Calibrators		
Model	CA111	CA114/CA115
Standard	IEC60942:2003 Class 1, ANSI S1.40-1984, GB/T 15173-1994	IEC60942:2003 Class 2, ANSI S1.40-1984, GB/T 15173-1994
Sound Pressure Level	94.0 dB ±0.3 dB and 114.0 dB ±0.3 dB	
Frequency	1000Hz ±0.5%	
Microphone Diameter	According to IEC61094-4: 1/2" & 1/4"	
Harmonic Distortion	<2% Stabilization Time: <10 s	
Equivalent Free-field Level	-0.2 dB for 1/2" Microphones	
Equivalent Random Incidence Level	+0.0 dB for 1/2", 1/4"	
Reference Conditions	Ambient Temperature: 25°C (77°F) / Ambient Pressure: 101.3 kPa / Humidity: 55% RH / Effective Load Volume: 250 mm ³	
Environmental Conditions	Temperature: -10°C-50°C (14°F -122°F) Pressure: 65 kPa to 108 kPa Humidity: 10 to 90%RH (non-condensing)	
Power Supply	Batteries: 1.5 V LR6 (AA battery) × 2 Lifetime: Typically 40 hours with alkaline batteries at 25°C (77°F)	
Dimension(mm)	48 × 70 × 70mm	
Weight	180 g, including batteries	



CA915 is a high sound pressure calibrator using the comparison method. The built-in compression driver delivers up to 164 dB at a small cavity. Two 1/2" (or 1/4" with the adaptor) holes where the reference and test microphones are installed were connected to the cavity. The sound pressure levels were measured simultaneously by the reference and test microphones. The comparison was made between two microphones and calibration value was then obtained. The compression driver can handle the frequency from 2 KHz to 10 kHz and it is possible to calibrate the microphone at multi-frequencies.



SPECIFICATIONS

High Sound Pressure Calibrator CA915	
Working Principles	Comparison Method
Test Objects	1/2" and 1/4"
Build-in Loudspeaker	280W Compression
Max output SPL	> 154 dB SPL @ 2000 ~ 10000 Hz > 164 dB SPL @ 2000 ~ 2500 Hz, 6200 ~ 6600 Hz
Frequency response	2 kHz ~ 8 kHz
Connector for Input	BNC
Net weight	14.5 kg

The MKV451 (optional item) is recommended as the reference microphone with upper-limit of 167 dB. A power amplifier (SWA100) is also required to drive the CA915.

CA916 The comparison method plays an important role in frequency response measurement, especially for nonmetal diaphragm transducer which cannot be tested by electrostatic actuator. Nonmetal diaphragm transducer can only be tested in direct method or the comparison method. Since the direct method is more susceptible to the environment, we have to turn to the comparison method which can eliminate the environmental effect.

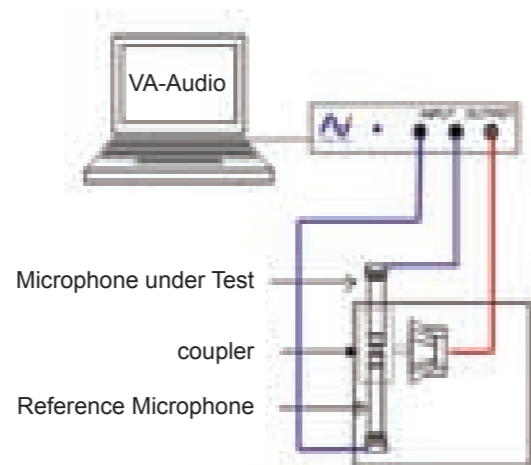

SPECIFICATIONS

Full Frequency Coupler CA916	
Working Principles	Comparison Method
Test objects	1/4" or 1/2" microphone
Frequency response	20 ~ 20k Hz
Size	110 mm × 95 mm × 90 mm
Net weight	1.2 kg
Build-in Loudspeaker	0.8W
Coupler Volume	1.13 cm ³
Reference Microphone	MPA231

The BSWA full frequency coupler CA916 is designed based on the comparison method. A 1/2" microphone is mounted inside the housing of the coupler as a reference. Properly designed cavity ensures that the sound pressure on the DUT transducer diaphragm is the same as the one on the reference microphone. The measurement frequency range is from 20~20K Hz.

EA002 is an electrostatic actuator designed and manufactured by BSWA for testing frequency response of microphones. An electrostatic actuator comprises an electric metal plate which can be placed near the microphone diaphragm. A time-various voltage is applied in between the metal plate and the diaphragm and thus an electrostatic force simulating sound pressure can be distributed on the diaphragm surface.



EA002 is especially designed for testing the

frequency response of 1" microphones. It can be placed directly on the diaphragm of a microphone. It also could be used for 1/2" and 1/4" microphones with the corresponding adaptor.

EA002 conforms to IEC 61094-6 standard and can be calibrated periodically with a sound level meter in accordance with IEC 61672-3 standard.

SPECIFICATIONS

Electrostatic Actuator EA002	
Standards	IEC 61094-6
Microphone Diameter	1"
Dimension	Φ35 x 17.5 mm
Weight	40 g

AS011 is the electrostatic actuator power supply. It have built-in signal amplifier of 30 dB. It can take the signal directly from a data acquisition card. AS011 can provide an 800V, 200V and 0V DC bias voltage to drive the electrostatic actuator.



SPECIFICATIONS

Electrostatic Actuator Power AS011	
Max. Input Voltage	1 Vrms
Gain	30 dB
Max. Output Voltage	25 Vrms
DC Bias Voltage	800 V, 200 V, 0 V
Frequency Range	3 Hz ~ 200 kHz
Output Impedance	100 Ω
Power Supply	15 VDC/220VAC
Dimension	275 x224 x 85 mm
Weight	3.4 kg

CS012 Calibration Stand CS012 is a platform for easy testing the technical specifications of the microphone in various situations.

The hollow pole in the middle of CS012 is used to fix preamplifiers. Square socket under the bottom is designed for cables. Locking devices are of 2 sizes which can be used for both 1/2" and 1/4" microphones.



SPECIFICATIONS

Calibration Stand CS012	
Matching Diameter of microphone	1/2" , 1/4"
Dimension	Φ150 mm × 15 mm (base) Φ20 mm × 145 mm (pillar)
Weight	400 g



BSWA designs and manufactures microphone arrays for acoustical measurements. Our experience spans from simple linear array to complicated random array. The number of microphones in the arrays ranges from 16 to 256 according to the customers' requirements.

Microphones are the most important elements in the array; BSWA uses MPA416 (or MPA466 with TEDS) for 1/4" microphone array. The phases of the microphones are matched according to the customer's specifications. For critical applications where high accuracy and low noise are required, BSWA will recommend MPA231 (or MPA271 with TEDS) as microphone elements

To make the array structurally stable, BSWA uses stainless steel (or aluminum) and CNC cutting to fabricate the mechanical parts.



SPS980 Spiral Array



SPS490 Spiral Array

SPECIFICATIONS

Microphone Arrays			
Model	SPT980	SPS980	SPS490
Type of Array	Spiral	Spiral	Spiral
No. of Microphones	36	36	16
Diameter	1.0 m	1.0 m	0.5 m
Microphone Model	MPA231T	MPA416	MPA416
Dynamic Range	17 ~ 136 dBA	29 ~ 127 dBA	29 ~ 127 dBA
Frequency Range	20 Hz ~ 20 kHz	20 Hz ~ 20 kHz	20 Hz ~ 20 kHz
Phase Match	±2 °	±5 °	±5 °
Cabling	8-pin LEMO - 8 SMBs	8-pin LEMO - 8 SMBs	8-pin LEMO - 8 SMBs

Study of array algorithm is a hot topic in the area of both acoustics and signal processing. BSWA can design and produce the microphone array based on the demands of customers. The following details are required when the customized microphone array is ordered:

- Positions of microphones to be fixed;
- Number of microphone to be used;
- Diameter of microphone to be used;
- Connector type of microphone to be used.

BSWA has the capability to design the mechanical structure, the layout of the cables, and the connector type of the Data Acquisition (DAQ).

To make the array structurally stable, BSWA uses stainless steel (or aluminum) and CNC cutting to fabricate the mechanical parts. The LEMO connectors are used for cables. Each Lemo connector corresponds to several microphones, so that the layout of the cable is very tidy.

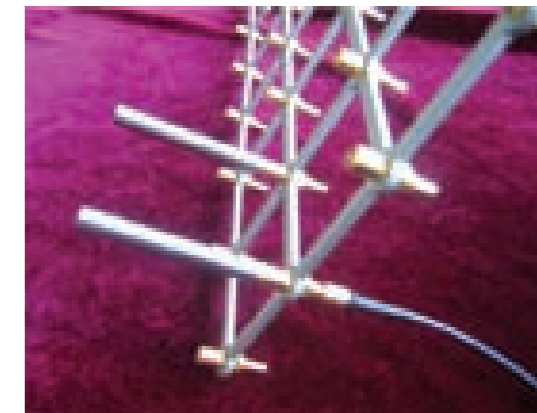

Mechanical structure of microphone array with 8x8 channels



Part of microphone array with 6 channels, Lemo Connector on the end

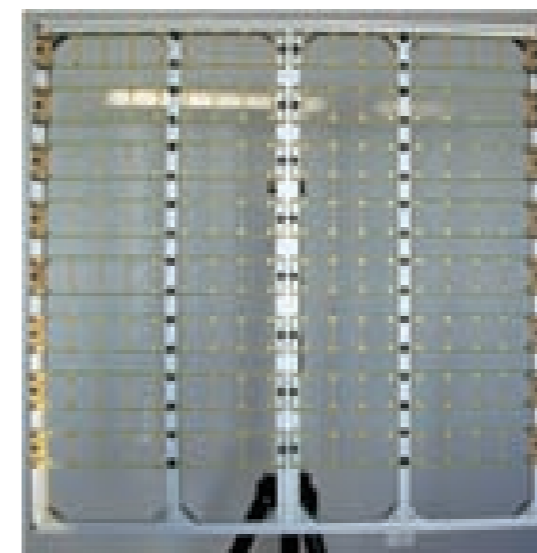

256-channel rectangular microphone array





In the measurement of sound power level according to ISO 3745-2003, the 20 measurement positions are required on a spherical measurement surface enveloping a noise source in anechoic and hemi-anechoic room. However, it is difficult to mount 20 microphones on tripods in a spherical surface.

BSWA developed MF720 (and MF710) microphone fixture specifically for such measurements. MF720 is designed according to ISO 3745-2003 to mount 20 microphones over the spherical surface; MF710 is a 10 positions version according to ISO3745; ISO7779 and GB6882.

MF720/ MF710 Main Features

- 20 / 10 microphone positions
- The position and orientation of each microphone can be adjusted to fit the amendment of the ISO standards
- Portable with light weight and the parts can be disassembled for easy transportation

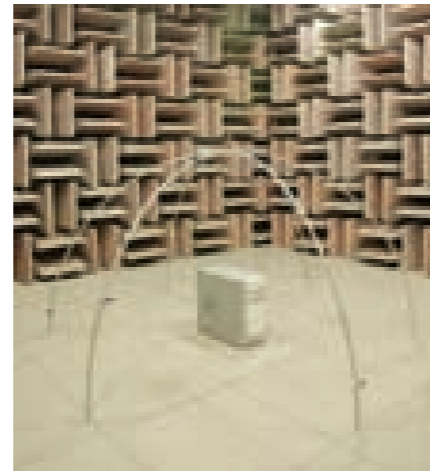

Microphone Mounting for MF710 and MF720

SPECIFICATIONS

Microphone Spherical Surface Fixture for Sound Power Testing		
Model	MF720	MF710
No. of Microphone Positions	20	10
Standards	ISO3745-2003	ISO7779, GB6882-88; ISO3475-1982
Radius (microphone positions) (mm)	1.0	1.0
Microphone Size to be Fixed on (inch)	1/2	1/2
Carrying Case (mm)	1500 × 350 × 200	1500 × 350 × 200
Weights(kg)	11	10
Optional Items		
MPA231 1/2" ICP Microphones	20	10
CBB 020 20 m BNC cables	20	10

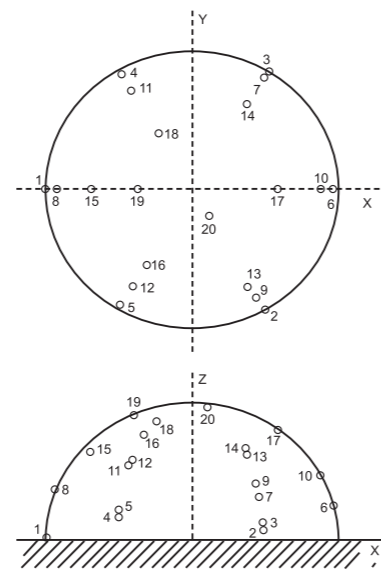

Microphone positions for MF720



Turntable TT325

TT325 is a turntable commonly used for directivity testing of loudspeakers and microphones. It uses a stepped motor and can be controlled precisely by pulse signals. The TT325 has built-in rotational 3-pin connector and can operate continuously without jamming the cables. The TT325 can be easily integrated into the audio testing systems. One output of the system generates the square waves to control the rotation and the other output generates the testing signals.

SPECIFICATIONS

Turntable TT325	
Speed Range (circles/minute)	1 ~ 20
Power Supply	18 ~ 50 VDC
Controlling Signal	800mV ~ 5V square wave
Control Precision	1/400°/pulse, 0.005°
Operating Temperature	0 ~ 50
Weight	About 10Kg
Max. Speed	3 circles/second
Size(mm)	165 (height) × 325 (diameter)

D/A Converter MT102

Digital microphone is becoming popular in Cellphone for stereo and multi microphones solutions. The output signal from the stereo digital microphones is encoded by Pulse Density Modulation (PDM). The MT102 is a D/A converter which separates the PDM digital signals into two channel analog signals. The analog signals are then input into the audio analyzer (such as VA-Audio system) for analysis. The MT102 works with the PDM signals from one or two digital microphones. It can separate the left and right output signals of the digital microphones.

MT102 has one control channel which can be used to activate the measurements automatically. The control signal is connected to the computer by USB cable.



SPECIFICATIONS





D/A Converter MT102	
Input Signal	PDM
Output Signal	Analog
Output Channels	2
Clock Frequency	2.45 MHz
Power Supply	12 VDC
Control Signal	3 VDC
Control Port	USB
Size (mm)	153 x 121 x 46
Weight (kg)	0.6



Data Acquisition Hardware

MC3622 / MC3022 / MC3122 / MC3242 / MC3642/ MC3640

The data acquisition hardware produced by BSWA is suitable for collecting data for noise and vibration measurement. The input channels supply ICCP power current. It is very convenient to be used with all kinds of ICCP type microphones or other sensors. Most BSWA data acquisition hardware has output channels, and can be used for audio and impedance measurements.

Model	MC3622	MC3022	MC3122	MC3242	MC3642	MC3640
Photos						
Input Channels	2	2	2	4	4	4
Max. Input Voltage (Vrms)	2	2	20	3.6	3.6	3.6
ICCP Power Supply (mA)	4	4	4	4	4	4
Output Channels	1, with 38W power amplifier	1	2	2	2	0
Max. Output Voltage (Vrms)	1.0	1.0	1.0	1.0	1.0	1.0
Standards (IEC 61672)	Type II	Type II	Type II	Type I	Type I	Type I
Input Connector	BNC	BNC	BNC	BNC	BNC	BNC
A/D Converter (bit)	16	16	16	24	24	24
Max. Sampling Frequency (Hz)	44.1k	44.1k	44.1k	51.2k	51.2k	51.2k
Gains	--	--	× 0.1, × 1, × 10	--	× 1, × 10, × 100	× 1, × 10, × 100
Internal Noise (dBA)	35	35	18	30	18	18
Frequency Response (Hz) (Ref: 250 Hz, +0.5 dB/-1.0 dB)	20 ~ 20k	20 ~ 20k	20 ~ 20k	20 ~ 20k	20 ~ 20k	20 ~ 20k
Measurement Range (dBA) (MP201)	35 ~ 125	35 ~ 125	18 ~ 146	30 ~ 130	18 ~ 130	18 ~ 130
Connector to the Computer	USB	USB	USB	USB	USB	USB
Power Requirement	USB (220 V or 110 V when power amplifier works)	USB	Internal rechargeable battery /220 V with power adaptor	USB	220 V (with power adaptor)	USB
Size (mm) (Length×Width×Height)	280 × 230 × 90	160 × 120 × 45	280 × 230 × 90	240 × 190 × 50	280 × 230 × 90	280 × 230 × 90
Weight (g)	4000	610	3500	1350	3600	3600

BSWA



VA-Lab is acoustical measurement software developed by BSWA. VA-Lab takes the advantage of computer power and performs all signal analysis within the computer. With BSWA Data Acquisition Hardware and Microphones, VA-Lab represents the most cost-effective solution for all your needs in acoustic measurement and analysis.

VA-Lab is developed based on the international standards and BSWA's experiences in acoustics. These experiences cover environmental, architectural, material and industrial measurements. VA-Lab has module design with special applications according to ISO standard requirements, such as Sound Power, Sound Insulation, and Impedance Measurements.

The VA-Lab Main Application Modules Include:

- **BASIC:** FFT based signal analysis for vibration and acoustics
- **ENV:** Sound pressure level and environment noise measurements
- **IMP:** Two or four microphone methods for absorption and TL measurements in Impedance tube according to ISO10534
- **SI:** Sound intensity measurements
- **REV:** Reverberation time measurements according to ISO3382
- **TL:** Sound Insulation measurements for building material according to ISO 140.
- **POWER:** Sound Power Measurements according to ISO3745.



Environment Module

VA-Lab ENV is a powerful sound level meter. It supports maximum 10 channel sound pressure level measurements at 10 locations. Each channel can perform multi-task analysis such as statistical levels, 1/3 octave, and levels vs. time.

VA-Lab ENV has built-in data logger function, it can continuously log the overall and spectral data into the memory.

Impedance Tube Module

Impedance Tube Module is for impedance tube measurements. It supports sound absorption and sound insulation measurement for BSWA SW series impedance tubes. The software works with BSWA MC3022, MC3522, MC3242 and MC3642 hardware for data acquisition and analysis.

VA-Lab IMP supports two methods to measure the absorption coefficients of material:

- Method using Standing Wave Ratio (ISO10534-1)
- Transfer Function Method (ISO10534-2)

Sound Intensity Module

The measurement of Sound Intensity provides information of magnitude and direction of the sound field, which is used in a variety of applications such as the determination of sound power and the noise source localizations.

VA-Lab SI module provides a simple system for sound intensity measurements. The system requires two-channel (or two channels of multi-channel) data acquisition hardware and intensity probe SI512. With BSWA VA-Lab SI module, the measurements of sound intensity become very easy task.

Sound Power Module

In order to determine the sound power level produced by the noise source, one method is to measure the sound pressure level on the measurement surface enveloping a noise source.

VA-Lab Power module is specially designed to satisfy sound power level test according to ISO3745. With NI Compact DAQ and BSWA microphones, the noise level can be tested simultaneously in 10 channels; the sound power level is calculated automatically based on the measurement surface area.

With microphone conditioning unit MC104 (MC1010 is 10 channel version), the background noise can be below 20 dBA for some critical measurements.

Architectural Module

VA-Lab ARCH module provides reverberation time measurements and sound transmission loss measurements according to ISO standards. The main features of VA-Lab ARCH are as follows:

- Two methods: interrupted noise, impulse response measure reverberation time in 1/1 or 1/3 octave frequencies according to ISO 3382
- Sound pressure decay curves display, support user-defined reverberation time calculation
- Airborne sound insulation of building elements Measurement
- Measurements of impact sound insulation of floors
- Automatically calculate single-number quantity: R_w , X_w , and its spectrum adaptation



SW series Impedance Tubes can accurately measure sound absorption coefficients and impedance according to ISO10534-2. They also support the sound transmission loss measurements based on the Transfer Function Method. The Transfer Function Method separates the incident and reflected energy from the measured transfer function, and then estimates the acoustic properties of the tested sample installed in the tube.

The SW series Impedance Tubes are specially designed not only to work with the cut samples, but also for direct use in the field. The small size and durable aluminum construction make it easy to be transported and used for estimating the properties of walls, ceilings, installed building materials, road surfaces, different ground surfaces, interiors of vehicles, and etc.

BSWA offers the complete set of Impedance Tube system, which includes: the tubes, microphones, DAQ hardware, and measurement software.

BSWA 1/4" microphones MPA416, which have excellent phase matches, is ideal for impedance applications. The microphones are directly connected to optional 2-channel MC3022 or 4-channel MC3242 data acquisition hardware. PA50 power amplifier is used to drive the loud speaker in the impedance tube. The BSWA VA-Lab software provides all measurement functions for sound absorption and transmission loss testing.



SW422



SW477

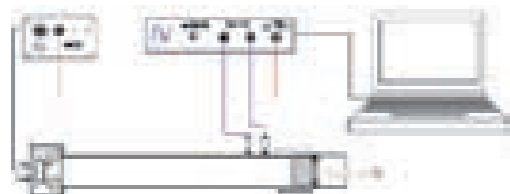

Impedance Tube System for Sound Absorption Measurement



Impedance Tube System for Transmission Loss Measurement

SPECIFICATIONS

Impedance Tube				
Model	SW420	SW470	SW422	SW477
Value to be Measured	Sound Absorption Coefficient (α)		Sound Absorption Coefficient (α) and Transmission Loss(TL)	
Standard	GB/T-18696, 2-2002, ISO10534-2, 1998		Sound Absorption Standard: GB/T-18696, 2-2002, ISO10534-2, 1998; Transmission Loss(TL) Standard in Discussion	
Frequency Range (Hz)	63 ~ 1800	800 ~ 6300	63 ~ 1800	800 ~ 6300
Inner Diameter of Testing Tube	100 mm	30 mm	100 mm	30 mm
Loud speaker	4 " in diameter, 20 Watts, 8 Ohm			
Optional Items Provided by BSWA				
1/4" Microphone	MPA416			
Data Acquisition Card	MC3022+PA50 or MC3622		MC3242	
Power Amplifier	PA50			
Software	VA-Lab2 Basic + VA-Lab2 IMP-A		VA-Lab4 Basic + VA-Lab4 IMP-AT	

R-Cabin is a small reverberation chamber which can be used to measure the sound absorption of materials for automotive industries.

R-Cabin FEATURES

- Appropriate for measurement of sound absorption characteristics of small and irregular samples, such as car seat, roof panel, carpet and etc.
- The size of the tested sample can be up to 3 square meters
- Frequency range: 400~10000Hz

APPLICATIONS

- Designing and optimization of the inner-car decoration acoustic system.
- Testing of the sound absorption coefficients of the inner-car items.
- Quality Control of the tested items
- R&D of new materials and new items.

R-Cabin small reverberation chamber uses steel panes in its structure. The sound absorption quantity of the empty cabin is small to ensure the accuracy of the testing of the Sound Absorption Coefficients of the samples. R-Cabin has exceptional sound insulation characters so that the outer noises have no effects on the testing.

The bottom of R-Cabin is designed to be vibration-resistant. There are four wheels fixed to the cabin for easy movement. There are two omni-directional loudspeakers on the upper and base corners in the cabin individually as the sound sources. There are four microphones to make reverberation time measurements.

The System Consists of

- R-Cabin
- 4-Channel Data Acquisition and sound generator instrument MC3242 or MC3642
- 4 sets of microphones MPA 231
- 2 sets of OS002 sound source
- Audio Amplifier SWA-100
- VA-Lab software
- Standard samples for checking the measurement



Measurement System

R-Cabin is equipped with a complete set of measurement system. The system emits pink noise to drive the two sound sources in the cabin and receives the signals from the four microphones. The reverberation time from the four channels is calculated automatically. The whole calculation is controlled by the computer for easy the operation.

Together with the R-Cabin, BSWA also provides standard testing samples. With the certified results, the customers can use the standard samples for reference measurements.

SPECIFICATIONS

Small Reverberation Chamber R-Cabin	
Parameter to be tested	Sound Absorption Coefficients, Reverberation Time
Testing Channel #	4
Noise Generator Channel #	2
Frequency Range	400 Hz ~ 10000 Hz
Max. Sample Size(m)	2.3 x 1.7
Cabin Size(m)	2.35 (Length) x 1.5 (Width) x 1.63(Height)
Door Size(m)	0.8 x 1.3
Weight(Kg)	800



VA-Audio is a software module for characterizing the performance of electro acoustic products, audio electronics, and transducers. With the simplicity of operation required for production line QC, yet the extensive analysis tools necessary for R&D, VA-Audio is suitable for use throughout the design and manufacturing process.

Acoustic characteristic of product is electrocircuit-independent. The structure of loud speaker is important for its specifications. The best way to get frequency response and the harmonic distortion is by testing. The general method is to use signal generator to control the speaker to make a noise, and to use microphone to capture the noise and then to analysis the result.

BSWA audio test system consists of VA-Audio software, 2-channel data acquisition hardware, and standard microphones. The artificial mouth, artificial ear or Test Box are all optional items for audio measurements.

Main Features of VA-Lab Audio:

- Modes of Operations: Stepped Sine, Frequency Sweep, Multi-tone, and User-defined
- Real-time frequency analysis. Frequency response, THD, and Impedance test in one time
- Support autocontrol. With USB control, software can start or stop automatically which is very convenient for online test.
- Test result can be saved and counted automatically
- Supports maximum 30th order of harmonic distortion. User-defined distortion components can be calculated in one test
- Automatic adjustment for output signals to make flat response of sound sources.
- Support Directionality Test, With BSWA turntable, software can control the rotate speed and test every frequency one by one or together
- Phase test

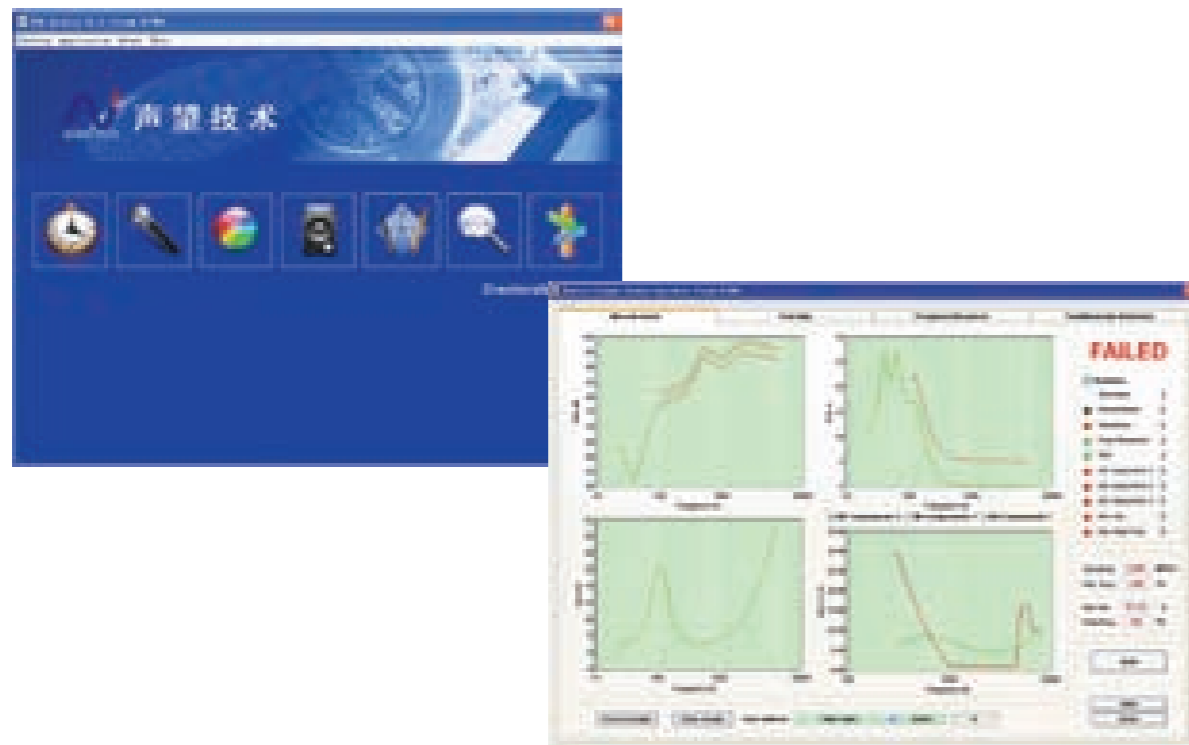

AM012



BSWA mouth simulator AM012 is developed for use in the testing of telephone, cell phone and other electro-acoustic parts where a sound field similar to the human voice field is required. AM012 produces a continuous output of 94 dB (200~8000Hz) at MRP (25mm from lip ring) and a continuous SPL of 110 dB (200~2000Hz) at MRP.

AM012 conforms to standards IEEE 269, IEEE 661 and ITU-T Rec. P51.

SPECIFICATIONS

Mouth Simulator AM012	
Standards	IEEE 269,661; ITU-T P.51
Output SPL	94 dB (200-8000Hz), 110 dB (200-2000Hz)
Opening Size	20mm in diameter
Source	8Ω/20W
Dia.of lip ring	40mm
Height of lip ring	10mm
Size	Diameter:100mm; Height:98mm
Weight	1.1Kg

SPECIFICATIONS

Artificial Ear		
Model	AE002	AE711
Conforms standards	IEC60318; ITU-T P.57	IEC711; ITU-T P.57
Microphone (Opt.)	MP251/MP253	MP253
Pre-amplifier (Opt.)	MA231 ICCP	MA221(or MA231) ICCP
Measurement parameter	Refer to MP253/MA211	Refer to MP253/MA221
Size	ø 40mm x 120mm	ø 23.8mm x 36.5mm
Weight	1.2 Kg	100 g

AE002



Human ear has a very complicated construction. Artificial ear is a receiving device in conformity to the human ear.

BSWA AE002 is designed for receiving response measurements. The design is based on the specifications in the standards IEC60318 and ITU-T P.57. It can be widely used in cell phone, telephone and electro-acoustic parts' testing.

AE711



BSWA ear simulator AE711 is composed of an IEC711 coupler and a press field microphone with pre-amplifier; it can be used for telephone, cell phone and earphone testing.

AE711 conforms to standards IEC711 and ITU-T P.57.



ABox260 is a small anechoic box fitted with modified ITU-T P.57 Type 3.2 simplified pinna simulator. It uses IEC711 artificial ear coupler for testing ear-speakers in the factory environments. ABox260 meets the ITU-T Rec. P.57 Artificial Ear Type 3.2 high-leak requirements.

The box is made of aluminum plate. The internal surface is fitted with BASOTECT sound absorption material. Type 3.2 simulator is fitted on top of the box. The Device Under Test (DUT) can be installed on simulator via the application adaptor.

To reduce the environmental noise, a silencer is specially designed. A linear bearing was used to move the silencer vertically. The DUT will be inside the silencer during the testing.

The pin-connectors are integrated with the silencer. When the silencer is pressed down, the pins will connect to the DUT to perform the testing. The pins also provide the 5-10 N force to the DUT.



SPECIFICATIONS

Ear Speaker Testing Box ABox260	
Standards	ITU-T Rec. P.57 and IEC60711
Size (mm)	260 x 250 x 500
Artificial Ear	AE711 with Pressure Microphone MP253 and MA221
Pinna Simulator	Type 3.2 High Leak
Calibration Parameter	Acoustical Input Impedance
Application Adaptor	Customized design
Force on the DUT	5 ~ 10 N
Weight	8 kg

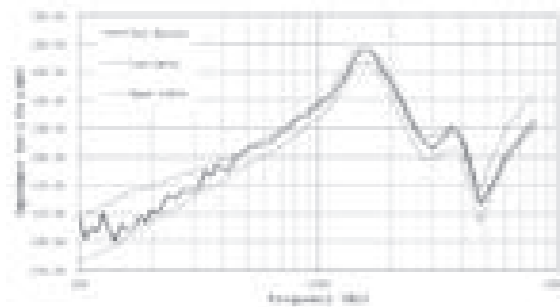

Acoustical Input Impedance Results of ABox260

FEATURES

- Designed according to ITU-T Recommendation. P.57 "Artificial Ear" (11/2005) Type 3.2 with high-leak simplified pinna simulator.
- Specially designed anechoic box for artificial ear.
- Specially designed silencer to reduce factory noise influence.

APPLICATIONS

- High volume ear-speaker testing based on Type 3.2 high leak ear in factory environments.
- Other product testing which requires Type 3.2 high leak ear

Acoustical Input Impedance

ITU-T P.57 specified the acoustic input impedance of Type3.2 high leak ear. Each box was tested for the impedance and the typical results are shown in the figure.

ABox380 is a small anechoic box fitted with a 1/4 inch microphone. The internal surface is fitted with sound absorption material. It is used for testing loudspeakers of cellphones in the factory environments. The external dimensions are the same as the ABox260. The application adaptors can be ordered for different size and configuration of loudspeakers or loudspeaker assemblies. The DUT is installed on the application adaptor and the presser is moved down to provide 5-10 N force and connections on the DUT. The top panel acts as the baffle as referred to IEC 60268-5 standard.



FEATURES

- Microphone is fixed at the precise position for repeatable measurements
- Microphone distances can be set to 10 mm or 30 mm by changing the front panel.
- Special designed calibration adaptors for calibration of microphone at the defined distance.
- Special design absorption foam in the anechoic box to reduce the reflections
- Each ABox380 was calibrated using Golden samples and comparing with the results of IEC60268-5 method

APPLICATIONS

- High volume loudspeaker testing in factory environments.
- Loudspeaker assembly testing for cellphones

SPECIFICATIONS

Loudspeaker Testing Box ABox380	
Standards	Referred to IEC60268-5
Size (mm)	260 x 250 x 500
Internal Size (mm)	160 x 170 x 90
Microphone Type	MPA416
Microphone distance (mm)	10 or 30
Calibration Adaptors	Two adaptors
Application Adaptor	Customized design
Force on the DUT	5 ~ 10 N





BHead230/248 is an artificial head for acoustic measurement and recording. The BHead230 /248 has simple design concept, which is "TO PUT MICROPHONES IN THE EARS". There is no fancy electronics or digital processing in the BHead230/248, just two microphones. The BHead200 accurately reproduces all acoustically relevant parts of the human outer ear, allowing aurally accurate binaural recordings of sound events. The main features are:

- Simple design and easy calibration
- Using two ICCP microphones, the signals can be directly to the analyzers and recorders
- Excellent phase matched microphones to ensure the binaural effects of hearing
- Large dynamic range from 25 dBA to 135 dBA

BHead230/248 uses analog techniques for signal output. This technology eliminates any additional errors causing by digital converters and filters. It can be used in the same way as conventional microphones.

APPLICATIONS

BHead BHead230/248 is designed for wide range of applications.

- Binaural recordings for sound quality analysis.
- Testing for headphones, earphones and audio products.
- Stereo recording for performing arts.
- Measurements of hearing protectors

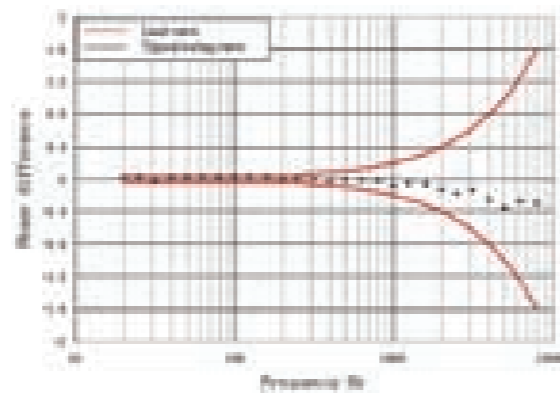

Phase differences of two microphones in BHead 230/248

SPECIFICATIONS

Artificial Head		
Model	BHead230	BHead248
Microphones Type	MP251	MP251
Sensitivity	-40 dB (10mV/Pa)	-40 dB (10mV/Pa)
Frequency Range	20 Hz ~ 20 kHz	20 Hz ~ 20 kHz
Power Required	ICCP	48V phantom
Dynamic Range	25 ~ 135 dBA	25 ~ 135 dBA
Background Noise	<25 dBA	<25 dBA
Phase Match	± 0.5 ° up to 8000 Hz	± 0.5 ° up to 8000 Hz
Sen. Match	± 0.2 dB	± 0.2 dB
Crosstalk	- 80 dB	- 80 dB
Output	BNC	XLR
Tripod Thread	UNC 3/8"	UNC 3/8"
Weight	6.0 kg	6.0 kg



VSS210 Volume Source is a mid-frequency volume source. It is ideal acoustical source for reciprocity measurements and TPA analysis. VSS210 uses a power speaker driver to deliver up to 125 dB over the frequency range from 200 to 10,000 Hz.

Two phase matched MPA416 microphones is installed at 2 cm apart in the outlet. The microphones provide the sound pressure and phase information for calculating the volume velocity radiated from the outlet.



SPECIFICATIONS

Mid-Frequency Volume Source VSS210	
Standards	NONE
Nominal Impedance	8 Ω
Power Handling	100 W continuous
Frequency Range	200 Hz ~ 10 kHz
Sound Power Level	120 dB Pink Noise
Connector	Audio Connector
Loudspeaker Unit	Compassion Diver 100 W
Tube Diameter	30 mm
Tube Length	3 m
Weight	5 kg
Carrying Case Dimensions	420 x 420 x 320 mm

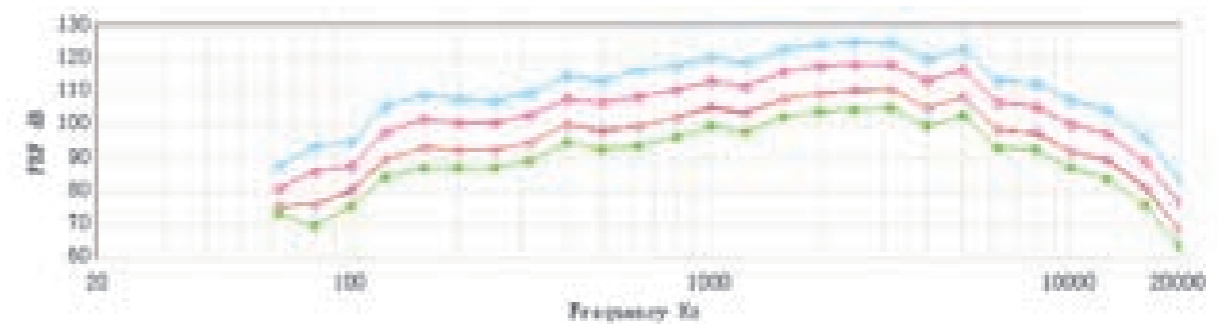
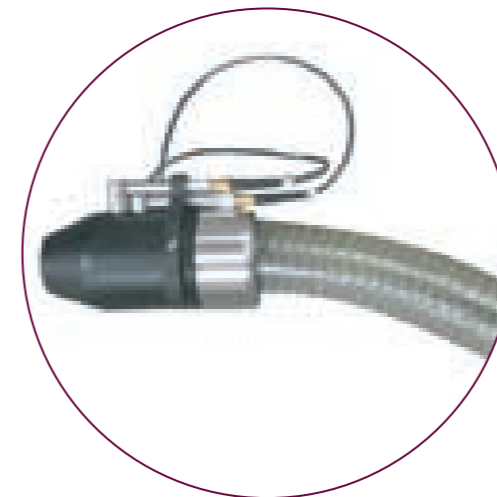

Frequency Response of VSS210 Measured at 5 cm from Outlet in the Anechoic Chamber

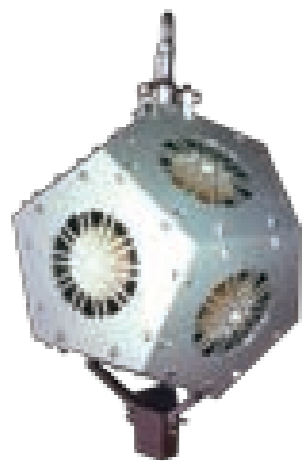

OS003 is a new style Omni Sound Source designed by BSWA. It uses 12 matched loudspeakers in a dodecahedral configuration. All the loudspeakers units are strictly selected and connected in a series-parallel network to ensure both in-phase operation and matching impedance.

The speaker enclosure is all metal providing a rugged, solid construction resulting in high acoustic performance. The OS003 is compact and about 12" (30cm) in diameter. With its high output power, it is an ideal choice for sound insulation, acoustic reciprocity and many other sound source measurements.

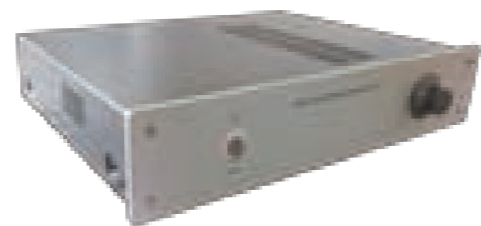

SWA100 Power Amplifier produces an amazing 100W per channel at 8 Ω for its incredibly compact size and low weight. It has the same features and protection circuits normally found only in more expensive, larger, and heavier amplifiers. Its two channels can be used independently of each other. The SWA100 is specially designed to use passive cooling removing the need (and noise) of a cooling fan.

SPECIFICATIONS

Omni-Sound Source OS003	
Standards	SO 140-3; ISO 3382; DIN 52210
Nominal Impedance	6 Ω
Power Handling	180 W continuous
Frequency Range	100 Hz ~ 8 kHz
Sound Power Level	115 dB Pink Noise
Connector	Audio Connector
Loudspeaker Units	4" Diameter; 8 Ω; 15 W
Diameter	310 mm
Weight	12 kg
Carrying Case Dimensions	320 x 320 x 320 mm
Power Amplifiers PA50	
Audio Power	50 W
Power Supply	220 V/110 V
Dimensions	330 x 210 x 90 mm
Weight	5.6 kg
Power Amplifiers SWA100	
Audio Power	100 W
Power Supply	220 V/110 V
Dimensions (including case)	495 x 430 x 150mm
Weight	12 kg



PA50 is a single-channel power amplifier with a power at 50W. Designed to be light weighted, PA50 is equipped with protection circuit that other power amplifiers of higher price have.

The PA50 is ideal unit for impedance tube and audio testing.

TM003 Tapping Machine is a rugged, self-contained sound source for making footfall noise measurements to the latest international standards (ISO140, EN 20140, ASTM E492, GB J75-84, etc.).

FEATURES

- Five 500g hammers with falling heights of 40mm
- 10 impacts per second
- Solid aluminum base for stable operation
- Reduced machine noise via belt drive
- Long lasting industrial drive motor
- No metal-to-metal moving parts resulting in less wear and smooth operation
- 24V DC power supply via a 220V/110V AC /DC adaptor.
- Remote control with an operating distance of 2 floors.

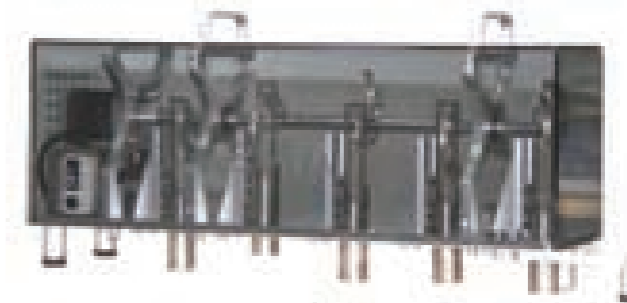

Principle of Operation

TM003 uses an industrial stepper motor turning five cams via a belt drive for quiet operation. The cams in turn lift the hammers which fall 40 mm to impact the solid and durable base plate at a rate of 5 impacts per second. The base is made from 3/16"(50 mm) solid aluminum making the unit very stable during operation.

Maintenances

Special consideration was given to all the moving parts of the unit. No metal to metal contact is allowed. Teflon washers and spacers are used to guide the hammers, reducing friction, wear, noise, and maintenance.



SPECIFICATIONS

Tapping Machine TM003	
Standards	ISO 140, BS5821, GBJ75, ASTM492, EN 20140
Hammers	Five in line, 100 mm between each hammer, single hammer weight 500±10g
Impact Frequency	Each hammer operates at 2Hz; tapping frequency for unit is 10±0.3Hz
Impact Forces	Equivalent free-fall height of hammers 40 mm
Motor	Stepper Motor
Dimensions	580 145 275 mm
Carrying Case	700 260 400 mm
Net Weight	10 kg (15 kg including the case)
Power supply	24V DC power supply via a 220V/110V AC /DC adaptor
Fuse	0.5A
Operating Temperature	-10 ~ 50
Operating Humidity	0 ~ 98% RH
STANDARD ITEMS INCLUDED	
TM003	1
Power Supply Adaptor	1
Remote Control	1
User's Manual	1
4mm L-type wrench	1
Testing Report	1
Carrying Case	1



iDosimeter 208 is a personal noise dosimeter developed based on iPhone and Android smartphones. It is designed for industrial hygiene and safety professionals to monitor noise exposure efficiently and provides tools to empower worker self-management of noise exposure. It is convenient and cost effective tool to manage the noise in workplace. The functions of the iDosimeter 208 are easily updated by software on the phones.



FEATURES

- Accuracy within 2 dBA for Leq; 3dBA for SPL
- Support iPhone 4 and 4s and Samsung Galaxy S2 and S3
- A, C, Z Frequency Weighting for RMS and Peak
- Time Constant: F,S,I
- One time run with given time duration, and auto-stop, auto-save.
- Real-time SPL and sound exposure display, Sound exposure can be E, LEQ, % or 8 hours equivalent level.
- Peak monitor and self-locking when exceed criteria.
- Data logging given time intervals



The iDosimeter 208 uses MPi825 microphone which is specially developed for iPhone and smartphones with measurement quality. The phones will be automatically connected to MPi825 when it is plugged into the headphone jacket on the smartphones. The measurements will be started by clicking the application software.

The iDosimeter 208 is a new and innovative device to measure noise in workplace. The accuracy of the measurements will be improved through the software upgrading. The low frequency cutoff in the smartphones is corrected by the software.

SPECIFICATIONS

Dosimeter iDosimeter 208	
Standards	Depend on the mobile phone and Software to meet IEC 61252 2002, GB15952 2010-T
Microphone	MPi 825, Type 2, diameter: 4mm
Software platform	Android and IOS. Support third-party software.
Lever Meter	LXY(SPL), LXeq, LXYmax, LXYmin, LXpeak While X=A, C, Z, Y=F, S, I
Sound Exposure	SEL, E, percent of Limit
Frequency Weighting	A, C, Z
Time detector	F, S, I
Frequency Range	63 ~ 8k Hz
Measurement Range	80 ~ 130dB (A)
Precision	24 bits (Galaxy and iPhone 4)
Sampling Rate	48 kHz (Galaxy and iPhone 4)
Screen	Depended on mobile phones
Power	Battery of mobile phone
Operating Temperature Range:	As mobile phone
Size	As mobile phone
Weight	As mobile phone

BSWA308 /309 are low cost integrating sound level meters. BSWA308 complies with the IEC61672 Class 1 standards while BSWA309 complies with Class 2 standard.

The instruments feature an industrially designed housing which offers a high level of comfort and style. The 1/2" measurement microphones are equipped with TNC connector and can be operated or detached from the unit via microphone extension cable. The use of high precision 24Bits AD converter

makes the instrument an ideal choice for performing many applications such as environmental noise, vehicle noise, and industrial noise testing. It can measure three parameters simultaneously with the A, C, and Z frequency weightings and with F, S, and I time weightings.



BSWA 308/309 Sound Level Meter		
Standard	BSWA 308	IEC 61672 Class 1, IEC 60651 Class 1, and IEC 60804 Class 1
	BSWA 309	IEC 61672 Class 2, IEC 60651 Class 2, and IEC 60804 Class 2
Microphone	BSWA 308	MPA231T: 1/2 inch pre-polarized measurement microphone , Class 1, Sensitivity : 50mV/Pa Frequency Range :10-20kHz TNC connector
	BSWA 309	MPA309T: 1/2 inch pre-polarized measurement microphone , Class 2 Sensitivity : 50mV/Pa Frequency Range :10-12.5kHz TNC connector
Detection, filtering	All-digital signal processing	
Measurement functions	LXY(SPL), LXrms, LXeq, LXYsd, LXsel, LXe, LXYmax, LXYmin, LXPeak, LXN Where X is the frequency weighting : A, C, Z; Y is time weighting :F, S, I N is the statistical percentage of .1-99 arbitrary set	
Integration time	Integration time is optional	
Measurement	Automatic measurement The measurement data may be stored into the SD card with period of measure time	
Frequency weighting	Parallel A, C, Z	
Time weighting	Parallel F, S, I, and can measure Peak	
Octave	5 Octave:31.5 Hz, 63 Hz, 125 Hz, 250 Hz, 500Hz	
Machine noise	Electric signal : BSWA 308: 14dB(A), 17dB(C), 23dB(z)	Sound signal : BSWA 308: 21dB(A), 24dB(C), 32dB(z)
	Electric signal : BSWA 309: 18dB(A), 21dB(C), 27dB(z)	
Sound signal : BSWA 309: 23dB(A), 26dB(C), 35dB(z)		
Up limit	131 dB(A) (50mV/Pa microphone) Expandable up to 160dB (A)	
Frequency Range	10~20kHz	
Dynamic Range	102 dB(A)	
Range setting	High / low two steps , can be automatically / manually adjust	
AD digits	24	
Sampling frequency	48kHz	
Analysis rate	64 times / sec	
Noise curve	Domain shows the noise curve, History time: 1min, 2min, 10min optional	
LCD display	160x160 LCD, with backlight	
Storage	4G Micro SD(TF)	
Post-processing software	Use processing software VA-SLM to read the store files , analysis, and generate reports	
Export data	Use adapter (Micro SD to SD card sets), or directly connect the computer to read the memory card data files	
Output	AC (maximum output 5Vrms of), DC (10mV/dB), RS-232 serial interface	
Alarm	Can be set to Alarming	
Power	4 on the 5th 1.5V alkaline batteries (LR6/AA/AM3), sustainable use of more than 18 hours . It can also be an external 7-14V DC power supply	
RTC clock	Built-in backup battery. It is no need to reset when replacing the battery	
Operation Temperature	-10°C~50°C (14°F~122°F)	
Temperature measurement	Real-time temperature on the main screen	
Size	300 x 70 x36 mm	
Weight	About 620g, including batteries	
Optional Accessories		
Extension cords	5m, 10m, 50m Microphone to the host	
Printer	Miniature thermal printer, without ribbon, RS232 interface	



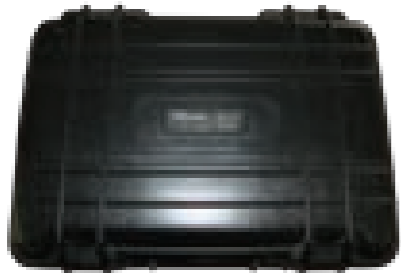

NMT 1000 Outdoor Noise Monitoring Terminal is a powerful and intelligent noise monitoring terminal optimized for outdoor use. NMT 1000 is a Hyper-Integrated noise monitor system that can be left unattended as part of an environmental noise monitoring system for mobile, fixed and semi-fixed monitoring. NMT 1000 terminal can store 12 days of noise data and transmit data via GPRS/CDMA. It can be used in all climatic environments, especially suitable for industrial, city, and field. The noise monitoring terminal can be remotely controlled by PC via GPRS/CDMA.

FEATURES

- Sealed enclosure meet IP65 standard.
- Suitable for stable, long-term, continuous outdoor monitoring.
- The power of NMT 1000 is possible from a variety of sources. For example an external UPS can be connected to replace the 220V supply.
- Remote operation via GPRS/CDMA, or be controlled via USB.
- 16M industrial flash memory for safe, long-term back-up.
- Onboard high stable and extremely accurate real-time clock (RTC), within ±2 minutes per year accuracy from -20°C to +50°C.
- 1-second Leq or SPL measurements.
- Dynamic range of 100 dB.
- The configuration software and post-process software operate on Microsoft Windows 2000, Windows XP or Windows 7.
- Post-processing software can create periodic statistical reports including SPL, Leq, Ln, Lmin, Lmax, and Ldn.
- Independent system supervisor makes sure that the system can be reboot from shut down or other accident.
- The NMT can be configured and calibrated by downloading data via GPRS/CDMA or USB.
- All-weather operation.

APPLICATIONS

- Airport, city, traffic, industrial noise monitoring
- Uninterrupted noise monitoring

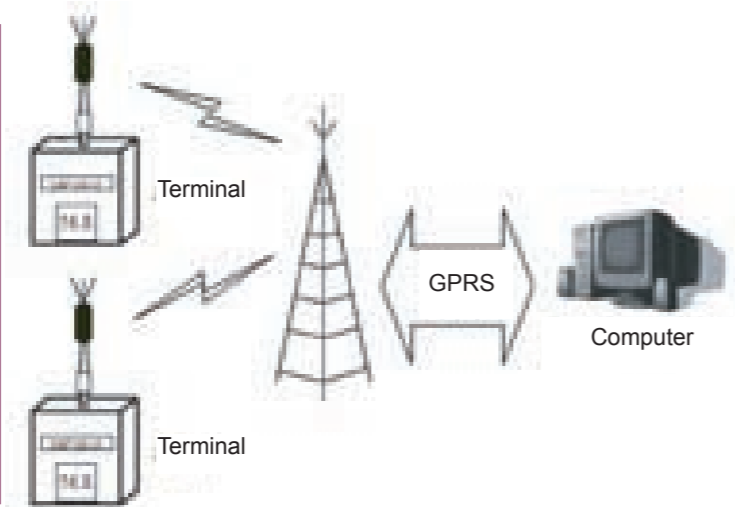

VA-EnvStan 1.0 Outdoor Software

Suit for terminal NMT 1000 is used to configure and download noise data (1-second Leq or SPL) and check the status of the system. It can also set the terminal date and time. VA-EnvStan 1.0 can operate via GPRS/CDMA and USB. The NMT1000 can store data in terminal memory, and VA-EnvStan 1.0 can download the noise data and save it as .txt file which can be input to VA-SLM outdoor software for further analyses.

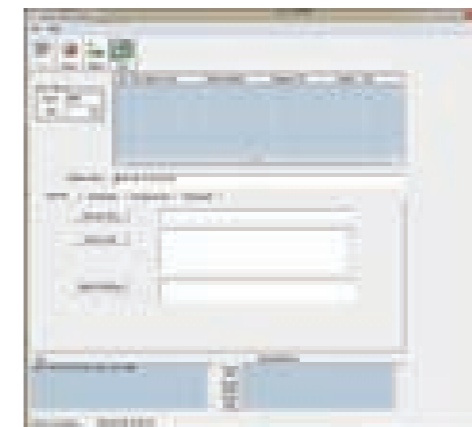

VA-EnvStan 1.0 FEATURES

- Download noise data via GPRS/CDMA. and USB and save data as .txt file.
- Configure and operate the NMT.
- Calibrate NMT.
- Check the status of NMT and get the system information.
- Download terminal operation log file.
- Save noise data automatically.

VA-SLM Outdoor post-process software

of NMT 1000 performs all the analyses needed for environmental noise measurements. It can calculate Ln, Lmin, Lmax, and etc. All values can be calculated for different period and create curve with selected average time. For example, you can get the statistical information of a whole day or every hour including Total Leq distribution and the quick results for a selected period calculating Leq, maximum values, minimum values and three Ln values (L10, L50, L90).

VA-SLM Outdoor Post-processing

- Calculate Calculate Ln, Ldn, Lmax, Lmin, and Leq for different period of time.
- Create curve with different average time
- Create periodic statistical reports



Model CBBnnn: BNC to BNC cables used to connect BNC microphones or transducers with data acquisition system or test equipment. Model number indicates cable length (i.e. BB020 for 20 m.)



Model CUBnnn: 10-32 UNF (or M5) to BNC cables commonly used to connect accelerometers or other transducers to acquisition system and analyzers. Model number indicates cable length. Also available are cables suitable for high temperature environments.



Model CSBnnn: SMB to BNC cables used for connecting SMB microphones to acquisition input channels.



Model CUUnnn: 10-32 UNF/M5 to 10-32 UNF/M5 Cables. Also available are cables suitable for high temperature environments.



Model CSSnnn: SMB to SMB Cables.



Model CLL7nn: 7 Pin LEMO female to 7 Pin LEMO male Cables. It is used with MV201 preamplifier.

Model CLS8nn: 8 pin LEMO male to 8 SMB connectors Cable. It is used with the microphone array.

Windscreens



WS002-9/WS004-9: 90 mm diameter, spherical windscreen for 1/2" or 1/4" microphones.



WS002-5/WS004-5: 50 mm diameter, spherical windscreen for 1/2" or 1/4" microphones.



WS002-3: Elliptical windscreen for 1/2" microphones.



Windscreen for outdoor microphones.

Adaptors for Calibration



AD002-1/2: Adapter from 1/2" to 1"



AD002-1/4: Adapter from 1/4" to 1/2"

Tripods



Tripods-01: It is used for microphones.

Tripods-02: It is used for Sound Level Meters.

Tripods-03: It is used for array.

Microphone Fixing Connectors

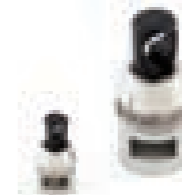

FC002/FC004: Used for fixing the 1/2" or 1/4" microphone to the fixture such as tripod with camera thread. It can also help to adjust the position of the microphone on the fixture.

Rain-protection Cap



OM-A02: It can be installed on the 1/2" microphones to protect from rain. When used for 1/4" microphones, an adaptor is needed.

Nose Cone



NC002: Specially designed windscreen for 1/2" microphones exposed to strong winds.

Microphone Adaptors for Preamplifiers



TA042: Adaptor for 1/4" microphone and 1/2" preamplifier.

TA021: Adaptor for 1" microphone and 1/2" preamplifier.

Rotation Stand for Microphone



MF701 is a microphone rotation stand designed according to ISO140 and GB19889. It is used for measuring space-averaged sound pressure level in the reverberation rooms. The MF701 rotates the microphones in the cycle motion. The microphones can be fixed on the arm in the MF701. The rotation speed is adjustable from 1 to 10 Rev/min.

BSWA Technology Co., Ltd.

Room 1003, North Ring Center
#18 Yumin Road
Xicheng District
Beijing 100029
China

Phone: 86 10 5128 5118

Fax: 86 10 8255 1626

Email: info@bswa-tech.com

Web: www.bswa-tech.com

